

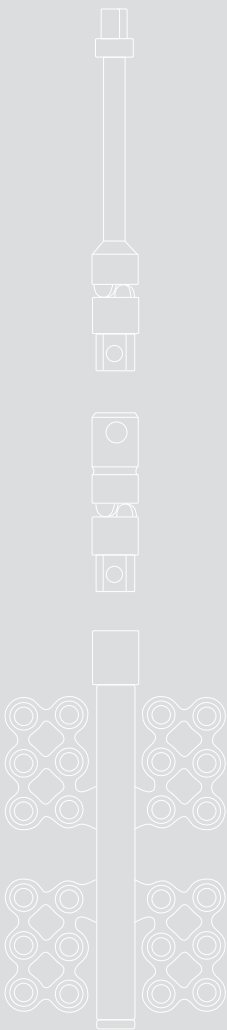

Distraction Product Overview

Sophisticated Distractors in CMF Surgery





KLS Martin Group is considered a worldwide technology leader in designing and manufacturing clinically approved distraction devices providing the most complete product range for cranio-maxillofacial indications. Scientific evidence of their use has been shown in numerous publications quoting the KLS Martin distractors as ideal tools for the surgeon's daily work and for the patient's benefit.

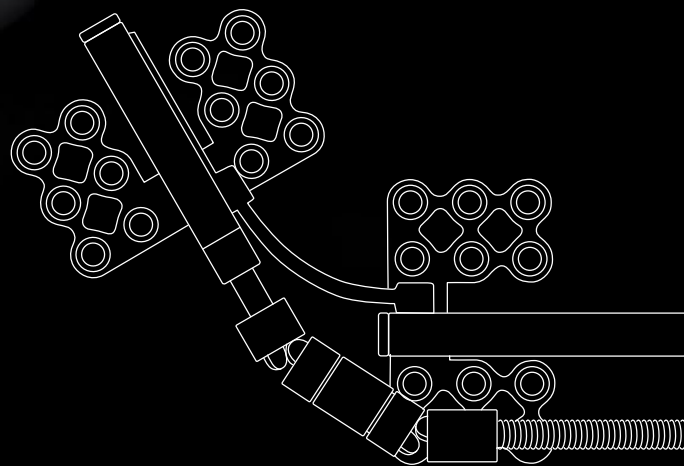

Distraction Product Overview

Table of Contents

	Pages
Distraction in Cranio-Maxillofacial Surgery	4 – 5
Vertical Alveolar Distraction	6 – 7
Mandibular Distraction	8 – 25
Maxillary Distraction	26 – 29
Transverse Maxillary Distraction	30 – 31
Transverse Mandibular Distraction	32 – 33
Midface and Cranial Distraction	34 – 37
External Distraction	38 – 41
Distraction Activators	42 – 45
Instruments for Distractor Placement	46 – 47
Screws, Drill Bits and Screwdriver Blades	48 – 49
Instrument for Vector Determination	50
Storage	51



TopSeller = most popular version of this distractor

Distraction in Cranio-Maxillofacial Surgery

A genius way to make bones grow

The insights regarding bone lengthening which the Russian surgeon Gavril Ilizarov gained in the 1950s are standard knowledge today – clinical practice would be unthinkable without it. More still: In many cases, distraction osteogenesis now represents the method of choice.

Distraction osteogenesis is based on the body's own ability to cause a fracture to heal and is described as the process of new bone formation between osteotomized bone segments that are gradually separated by incremental traction. Precisely, the process is initiated when distraction forces are applied to the callus formed between the two bone parts, and continues as long as these tissues are stretched; generally at a rate of 1 mm per day. The traction generates tension that stimulates new callus formation and in this way bone is lengthened continuously.

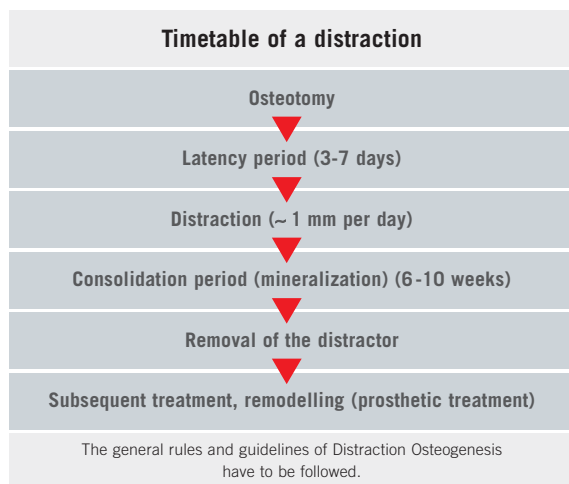

Distraction osteogenesis offers many advantages over conventional methods of treatment:

- No need for bone grafts.
- Minimal risk of infection because vital bone is distracted.
- Not only the bone but also the soft tissue is distracted, so that the new bone is permanently stabilized.
- The results of the distraction can be reproduced.
- Simple surgical procedure which does not essentially differ from standard osteosynthesis techniques used in CMF surgery.



Example of an operative approach:

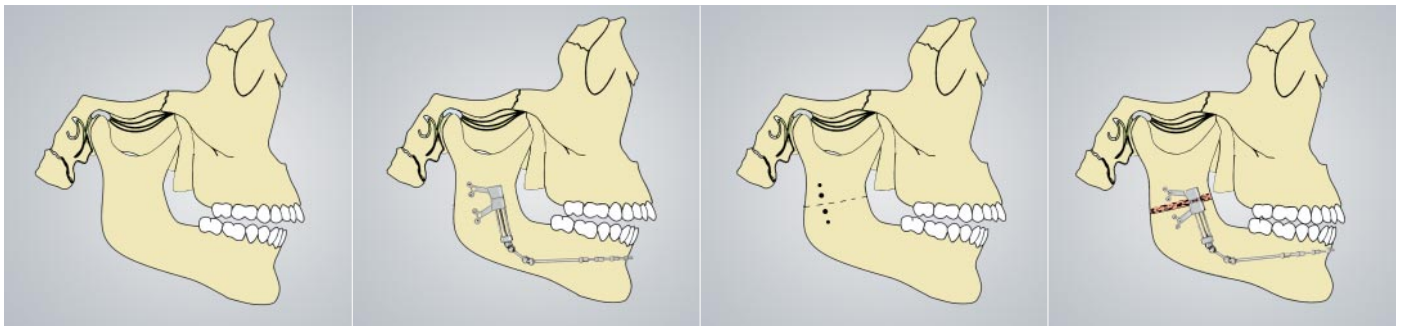

The surgical procedure is divided into the following steps, independent of the selected distraction system:

Exposing of the bone to be distracted, if possible by intraoral approach with vestibular incision.

Adaptation of the distractor to the bone and the required distraction vector and marking of the position by pre-drilling of at least two screw holes on each side of the osteotomy line.

Removal of the distractor and osteotomy. It is recommended to separate the bone completely.

Final fixation of the distractor with cortical screws and intraoperative test of the function of the distractor.

Closing of the wound and starting of the distraction after a latency period of 3 to 7 days.

Vertical Alveolar Distraction

TRACK Distractors



Micro TRACK
1:1 scale



TRACK 1.0
1:1 scale



TRACK 1 Plus
5:1 scale

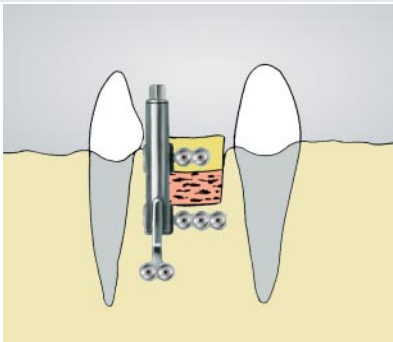

Micro TRACK

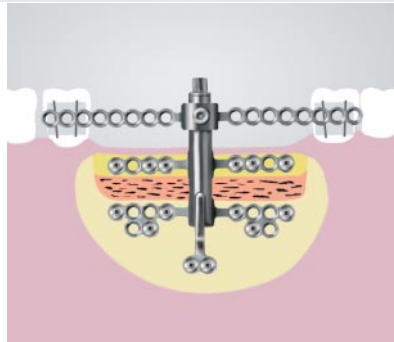

TRACK 1.0 with optional support plate 51-525-40-09

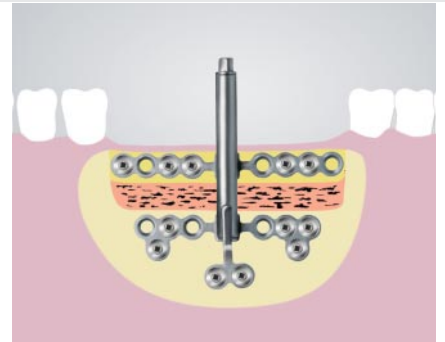

TRACK 1 Plus

Micro TRACK

Distractors	Item Number
Distraction length 9 mm	51-523-09-09
Distraction length 12 mm	51-523-12-09
Distraction length/turn 0.3 mm	

Recommended screws
1.0 x 4 mm to 1.0 x 6 mm
Emergency: 1.2 x 5 mm

Patient screwdrivers	
Straight	51-525-85-07
Combination straight and angled	51-525-90-07
Combination straight and angled for handle 25-402-99-07	51-525-91-04
Micro	51-525-95-07

TRACK 1.0

Distractors	Item Number
Distraction length 9 mm	51-525-09-09
Distraction length 12 mm	51-525-12-09
Distraction length 15 mm	51-525-15-09
Distraction length/turn 0.3 mm	

Optional	
Support plate for Micro TRACK, TRACK 1.0, TRACK 1 Plus	51-525-40-09

Recommended screws
1.0 x 4 mm to 1.0 x 6 mm
Emergency: 1.2 x 5 mm

Patient screwdrivers	
Straight	51-525-85-07
Combination straight and angled	51-525-90-07
Combination straight and angled for handle 25-402-99-07	51-525-91-04
Micro	51-525-95-07

TRACK 1 Plus

Distractors	Item Number
Distraction length 9 mm	51-524-09-09
Distraction length 12 mm Top Seller	51-524-12-09
Distraction length 15 mm	51-524-15-09
Distraction length/turn 0.3 mm	

Recommended screws
1.5 x 5 mm to 1.5 x 7 mm
Emergency: 1.8 x 5 mm
Drill-Free: 1.5 x 5 mm

Patient screwdrivers	
Straight	51-525-85-07
Combination straight and angled	51-525-90-07
Combination straight and angled for handle 25-402-99-07	51-525-91-04
Micro	51-525-95-07



TRACK 1.5
1:1 scale

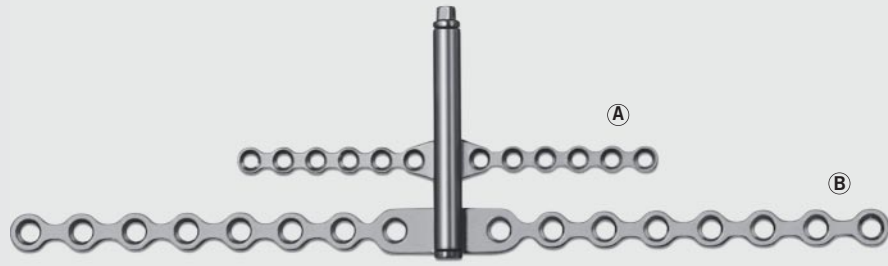

TRACK 2.0
1:1 scale

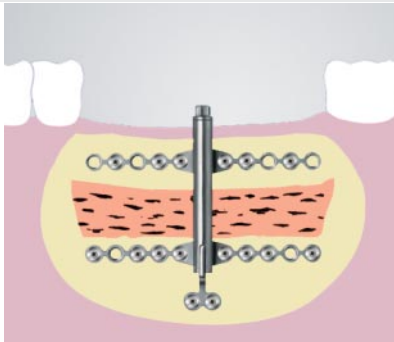

TRACK 1.5

TRACK 1.5

Distractors	Item Number
Distraction length 10 mm	51-520-10-09
Distraction length 15 mm	51-520-15-09
Distraction length/turn 0.5 mm	

Recommended screws	
1.5 x 3.5 mm to 1.5 x 7 mm	
Emergency: 1.8 x 5 mm	
Drill-Free: 1.5 x 5 mm	

Patient screwdrivers	
Straight	51-500-90-07
Angled	51-505-90-07
Combination straight and angled for handle 25-402-99-07	51-505-91-04
Micro	51-520-95-07

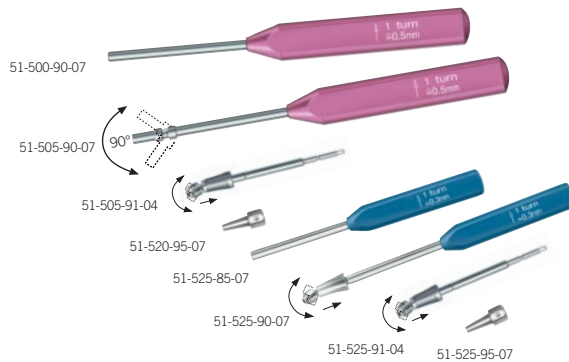

TRACK 2.0

Distractors	Item Number
Distraction length 10 mm	51-530-10-09
Distraction length 15 mm	51-530-15-09
Distraction length/turn 0.5 mm	

Recommended screws transport plate (A)	
1.5 x 3.5 mm to 1.5 x 7 mm	
Emergency: 1.8 x 5 mm	
Drill-Free: 1.5 x 5 mm	
Recommended screws base plate (B)	
2.0 x 4 mm to 2.0 x 7 mm	
Emergency: 2.3 x 5 mm	
Drill-Free: 2.0 x 5 mm	

Patient screwdrivers	
Straight	51-500-90-07
Angled	51-505-90-07
Combination straight and angled for handle 25-402-99-07	51-505-91-04
Micro	51-520-95-07



For additional product information, please refer to the brochure "Alveolar Ridge Distraction – Product Overview".

Note:
For all TRACK distractors, no activator is needed.

Mandibular Distraction

Micro Zurich II Distractors

Early intraoral distraction therapy for babies and infants aged up to one year requires distractors with an especially small profile to ensure that the distractor can be reliably covered with soft tissue. The Micro Zurich II product line has been designed with exactly this goal in mind.

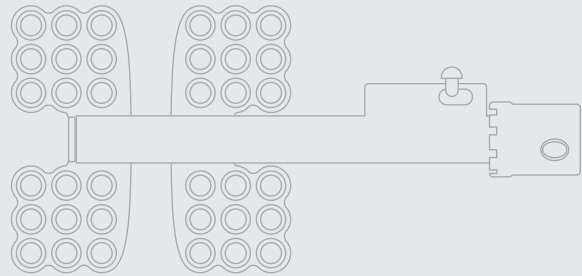

Micro Zurich II Distractors, end-driven

The posterior plate stays in place, while the anterior plate moves forward

End-driven	
(Mesh design, with anti-relapse ratchet)	
15 mm	51-424-15-09
20 mm	TopSeller 51-424-20-09
25 mm	51-424-25-09
30 mm	51-424-30-09
Distraction length/turn 0.3 mm	
Recommended screws	
1.0 x 4 mm to 1.0 x 7 mm	
Emergency: 1.2 x 5 mm	
Patient screwdriver	
Straight 51-430-95-07	

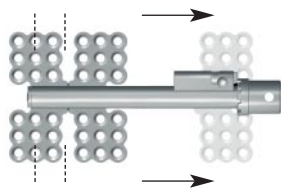

End-driven	
(Cloverleaf design, with anti-relapse ratchet)	
15 mm	51-428-15-09
20 mm	51-428-20-09
25 mm	51-428-25-09
30 mm	51-428-30-09
Distraction length/turn 0.3 mm	
Recommended screws	
1.5 x 4 mm to 1.5 x 7 mm	
Emergency: 1.8 x 5 mm	
Drill-Free: 1.5 x 5 mm	
Patient screwdriver	
Straight 51-430-95-07	

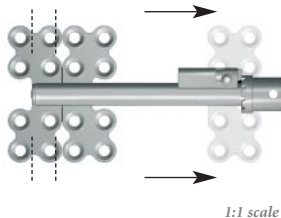

Micro Zurich II Distractors, middle-driven

Both plates move from central position bilaterally

(Mesh design, with anti-relapse ratchet)	
15 mm	51-423-15-09
20 mm	51-423-20-09
25 mm	51-423-25-09
30 mm	51-423-30-09
Distraction length/turn 0.6 mm	
Recommended screws	
1.0 x 4 mm to 1.0 x 7 mm	
Emergency: 1.2 x 5 mm	
Patient screwdriver	
Straight 51-423-95-07	

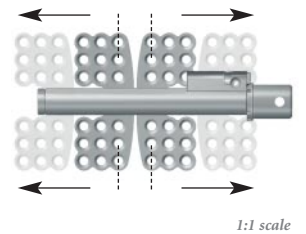

Activators
See pages
40 - 43



For additional product information, please refer to the brochure "Zurich II Modular Distraction Concept".

Product Features

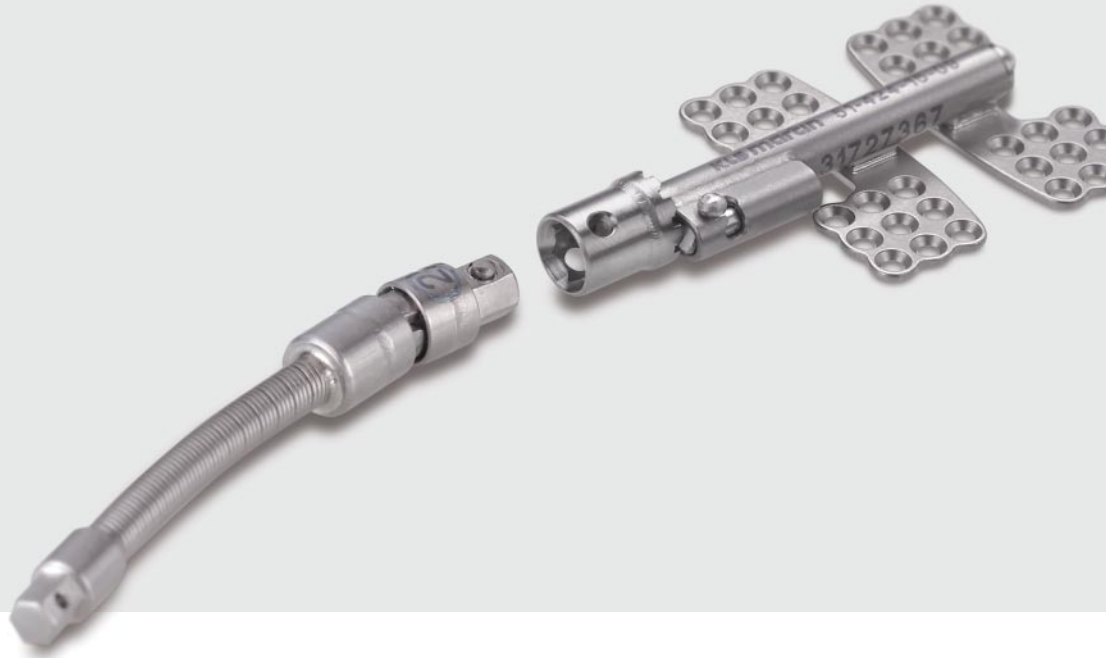

Symmetrical design

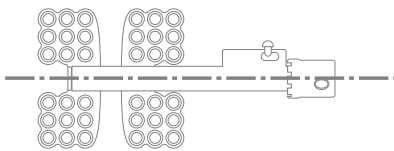

The symmetrical design allows you to use the same distractor on the left or on the right side. This reduces your stock-keeping needs and lowers the amount of capital tied up in distractors held in stock. The fixing plates can be cut to size intraoperatively to adapt them to individual anatomical requirements.

The plates available include the well-known cloverleaf plates and mesh designs. The distractors can be installed in place with the plates down or up.

Anti-relapse ratchet

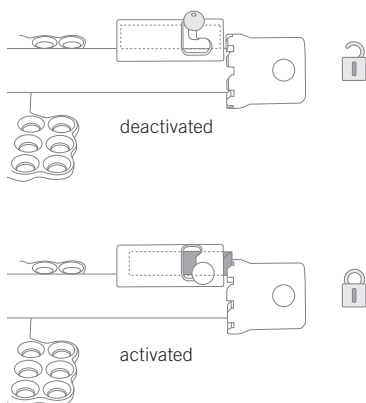

Some distractors of the Zurich II and Micro Zurich II product lines feature an anti-relapse ratchet that reliably prevents backward rotation of the distractor and consequential relapse of the distracted bone area. This stop can be deactivated intraoperatively for function test performance.

Mandibular Distraction

Zurich II Distractors



Zurich II Distractors, end-driven

The posterior plate stays in place, while the anterior plate moves forward

End-driven (Mesh design)	
15 mm	51-416-15-09
20 mm	51-416-20-09
25 mm	51-416-25-09
30 mm	51-416-30-09

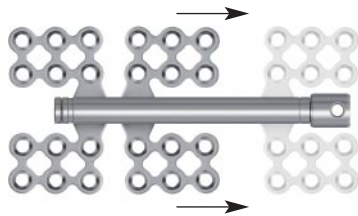

End-driven (Mesh design, with anti-relapse ratchet)	
15 mm	51-426-15-09
20 mm	51-426-20-09
25 mm	51-426-25-09
30 mm	51-426-30-09

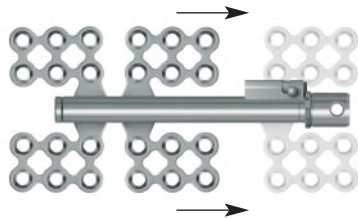

Distraction length/turn 0.5 mm

Zurich II Distractors, middle-driven

Both plates move from central position bilaterally

Middle-driven (Mesh design)	
15 mm	51-415-15-09
20 mm	51-415-20-09
25 mm	51-415-25-09
30 mm	51-415-30-09

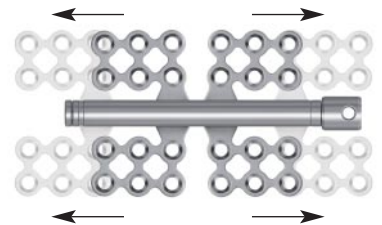

Middle-driven (Mesh design, with anti-relapse ratchet)	
15 mm	51-425-15-09
20 mm	51-425-20-09
25 mm	51-425-25-09
30 mm	51-425-30-09

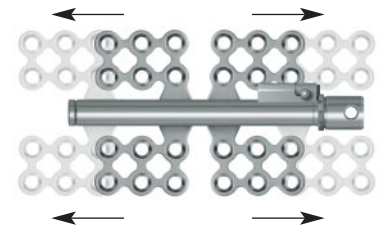

Distraction length/turn 0.5 mm

Activators
See pages
40 - 43



Recommended screws	
1.5 x 4 mm to 1.5 x 7 mm	
Emergency: 1.8 x 5 mm	
Drill-Free: 1.5 x 5 mm	

Patient screwdrivers	
Straight	51-500-90-07
Angled	51-505-90-07
Combination straight and angled for handle 25-402-99-07	51-505-91-04

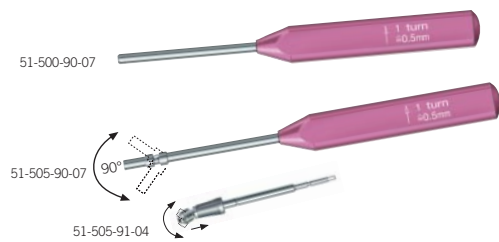





For additional product information, please refer to the brochure "Zurich II Modular Distraction Concept".





Mandibular Distraction

Zurich II Modular Distractors



Distractor Bodies

Version End-Driven	Description	Item No.
	Zurich II distractor body, right-side design, 15 mm	51-441-15-09
	Zurich II distractor body, right-side design, 20 mm	51-441-20-09
	Zurich II distractor body, left-side design, 15 mm	51-442-15-09
	Zurich II distractor body, left-side design, 20 mm	51-442-20-09 TopSeller

Version Middle-Driven	Description	Item No.
	Zurich II distractor body, right-side design, 15 mm	51-443-15-09
	Zurich II distractor body, right-side design, 20 mm	51-443-20-09
	Zurich II distractor body, left-side design, 15 mm	51-444-15-09
	Zurich II distractor body, left-side design, 20 mm	51-444-20-09

1:1 scale

Activators
See pages
40 - 43

Fixation Plates

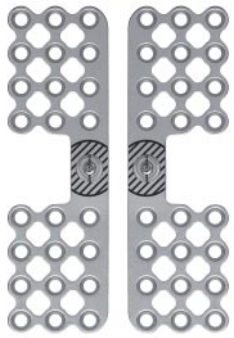
Version Mesh-Design	Description	Item No.
	Fixation plates (pair) for Zurich II distractor body, Mesh-Design	51-440-14-09 TopSeller

	Fixation plates (pair) for Zurich II distractor body, short, Mesh-Design	51-440-16-09
--------------------------------------------------------------------------------------	--------------------------------------------------------------------------	--------------

Version Cloverleaf-Design	Description	Item No.
	Fixation plates (pair) for Zurich II distractor body, Cloverleaf-Design	51-440-18-09

1:1 scale

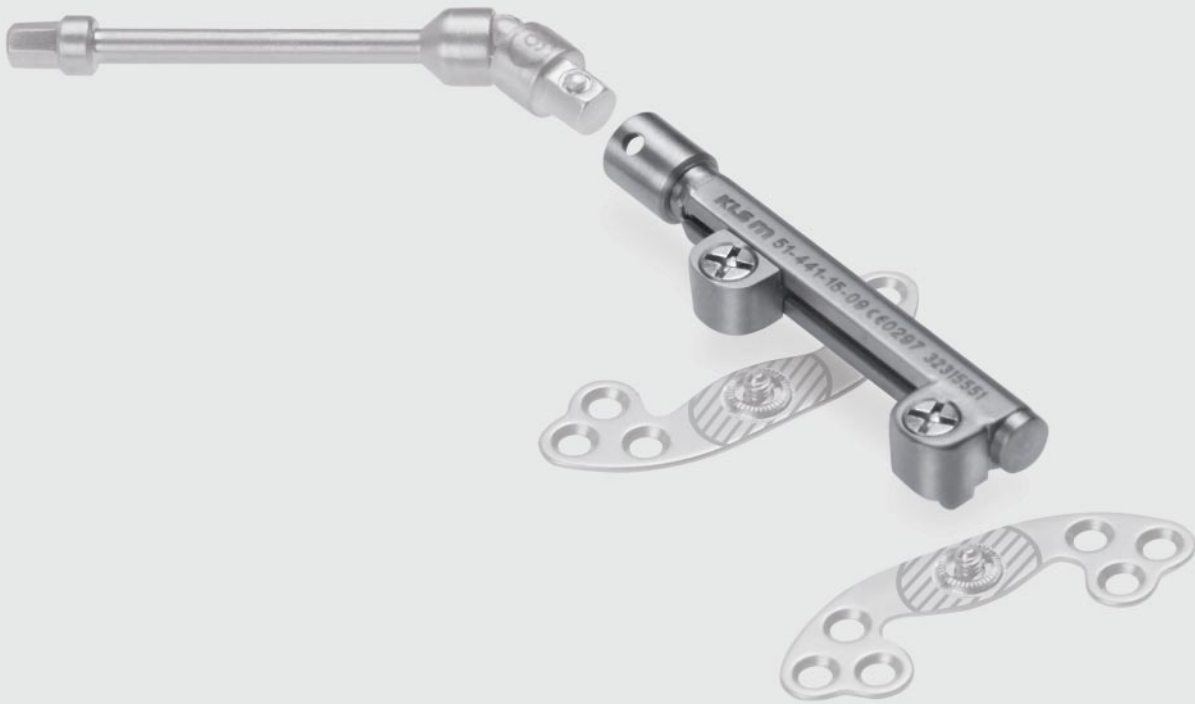

Recommended screws

1.5 x 4 mm to 1.5 x 7 mm

Emergency: 1.8 x 5 mm

Drill-Free: 1.5 x 5 mm

Patient screwdrivers

Straight 51-500-90-07

Angled 51-505-90-07

Combination straight and angled for handle 25-402-99-07 51-505-91-04



For additional product information, please refer to the brochure "Zürich II Modular Distractor".

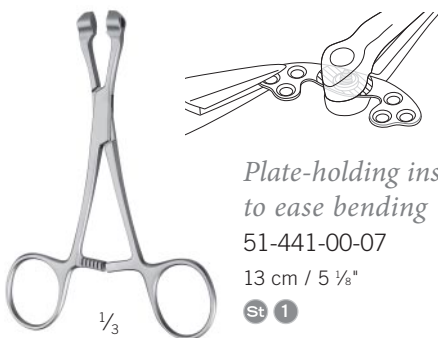
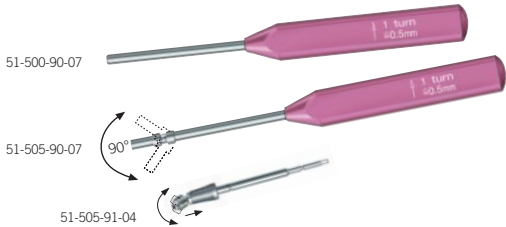
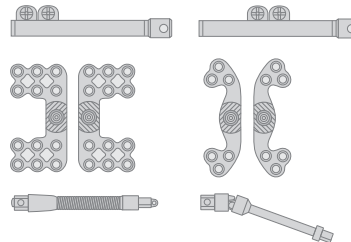

Plate-holding instrument to ease bending
51-441-00-07

13 cm / 5 1/8"

St 1

Completely modular design



The symmetrical design allows a patient-specific configuration of the distractor in accordance with anatomical conditions and individual requirements.

Removing the distractor body from the fixation plates

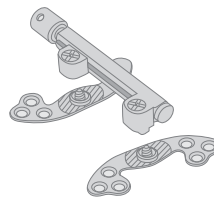

Following temporary in-situ fixation of the distractor, only the distractor body needs to be removed. The plates can be left in place on the bone to perform the osteotomy. This eliminates the difficulty of refixing the distractor to the mobile bone segments once the osteotomy has been performed.

Angular plate fixation on the distractor body

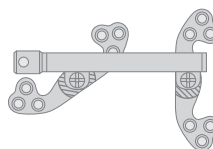

Both fixation plates can be connected to the distractor body at an angle. This enables lots of options to place the distractor on the mandible.

Mandibular Distraction

Zurich Pediatric Ramus Distractors



Zurich Pediatric Ramus, Cloverleaf design (flexible activator)

1:1 scale



Zurich Pediatric Ramus, Cloverleaf design (rigid activator)

1:1 scale

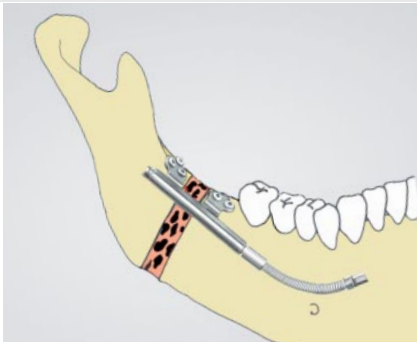

Zurich Pediatric Ramus, Cloverleaf design (flexible activator)

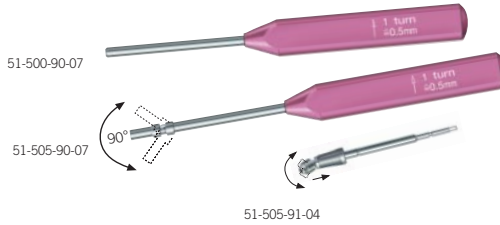

Zurich Pediatric Ramus Cloverleaf design (flexible activator)

Distractors incl. activator	Item Number
15 mm, left Top Seller	51-515-15-09
20 mm, left	51-515-20-09
25 mm, left	51-515-25-09
15 mm, right	51-516-15-09
20 mm, right	51-516-20-09
25 mm, right	51-516-25-09

Distraction length/turn 0.5 mm

Recommended screws
1.5 x 3.5 mm to 1.5 x 7 mm
Emergency: 1.8 x 5 mm
Drill-Free: 1.5 x 5 mm

Patient screwdrivers	Item Number
Straight	51-500-90-07
Angled	51-505-90-07
Combination straight and angled	
for handle 25-402-99-07	51-505-91-04

Zurich Pediatric Ramus Cloverleaf design (rigid activator)

Distractors incl. activator	Item Number
15 mm, left	51-511-15-09
20 mm, left	51-511-20-09
25 mm, left	51-511-25-09
15 mm, right	51-513-15-09
20 mm, right	51-513-20-09
25 mm, right	51-513-25-09

Distraction length/turn 0.5 mm

Recommended screws
1.5 x 3.5 mm to 1.5 x 7 mm
Emergency: 1.8 x 5 mm
Drill-Free: 1.5 x 5 mm

Patient screwdrivers	Item Number
Straight	51-500-90-07
Angled	51-505-90-07
Combination straight and angled	
for handle 25-402-99-07	51-505-91-04



For additional product information, please refer to the brochure "Zurich Pediatric Ramus Distractor".

Horizontal and Ramus Distractors

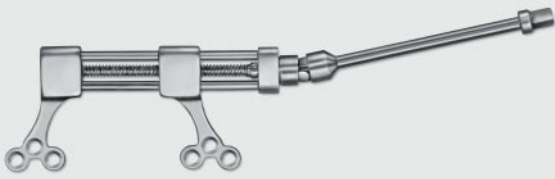

Horizontal Distractor
1:1 scale

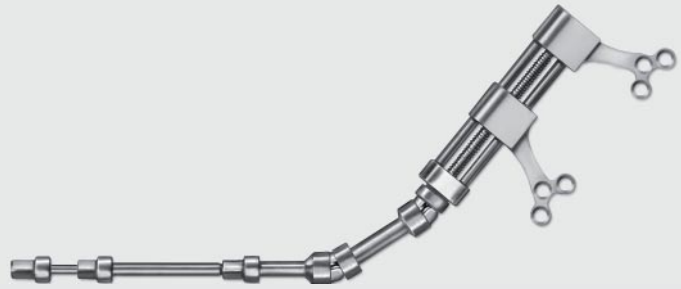

Ramus Distractor
1:1 scale

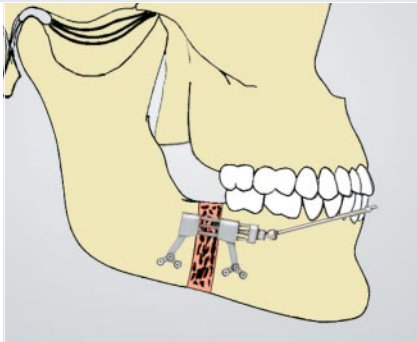

Horizontal Distractor

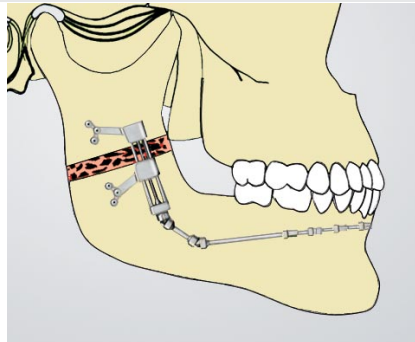

Ramus Distractor

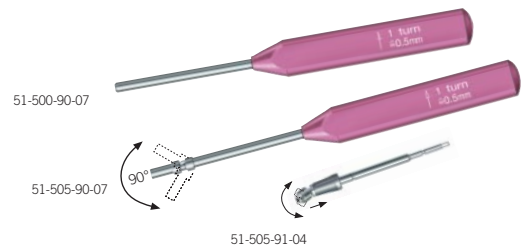

Horizontal Distractor

Distractors incl. activator	Item Number
10 mm	51-500-10-09
15 mm TopSeller	51-500-15-09
20 mm	51-500-20-09
Distraction length/turn 0.5 mm	

Recommended screws

1.5 x 3.5 mm to 1.5 x 7 mm

Emergency: 1.8 x 5 mm

Drill-Free: 1.5 x 5 mm

Patient screwdrivers

Straight	51-500-90-07
Angled	51-505-90-07
Combination straight and angled for handle 25-402-99-07	51-505-91-04

Ramus Distractor

Distractors incl. activator	Item Number
15 mm	51-510-15-09
20 mm TopSeller	51-510-20-09
25 mm	51-510-25-09
Distraction length/turn 0.5 mm	

Recommended screws

1.5 x 3.5 mm to 1.5 x 7 mm

Emergency: 1.8 x 5 mm

Drill-Free: 1.5 x 5 mm

Patient screwdrivers

Straight	51-500-90-07
Angled	51-505-90-07
Combination straight and angled for handle 25-402-99-07	51-505-91-04

- Low-profile distractors
- Symmetrical design – no right or left versions
- Fixation optionally with the plates downwards or upwards (for fixation in the oblique line)
- Cardanic activators offer maximum flexibility for intraoral activation.
- Activation arm is already included.

Mandibular Distraction

Right Angle Driven

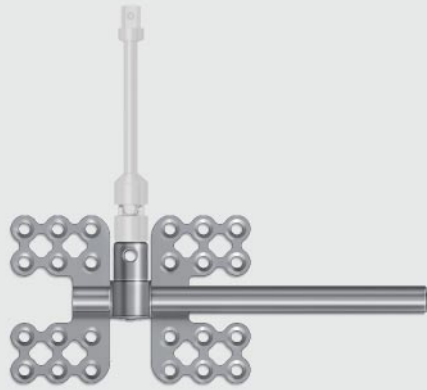

Right Angle Driven (RAD)
1:1 scale

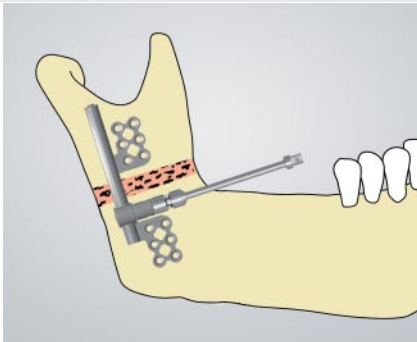

Intraoral fixation of a distractor with 90° activation

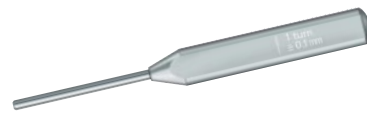

51-560-90-07

Right Angle Driven (RAD)

Distractors w/o activators	Item Number
20 mm, left	51-612-20-09
25 mm, left	51-612-25-09
20 mm, right	51-613-20-09
25 mm, right	51-613-25-09

Top Seller

Activators
See pages
40 - 43

Distraction length/turn 0.1 mm

Recommended screws
1.5 x 3.5 mm to 1.5 x 7 mm
Emergency: 1.8 x 5 mm
Drill-Free: 1.5 x 5 mm

Patient screwdrivers
Straight 51-560-90-07

Distraction of the ascending ramus is very demanding for intraoral distractors. Here, the surgeon normally prefers intraoral activation, however this is especially hard to accomplish because of the lack of space.

Due to the offset activator providing 90-degree access, these distractors offer excellent support in such situations, clearly facilitating intraoral activation.

Mandibular Telescoping Distractor

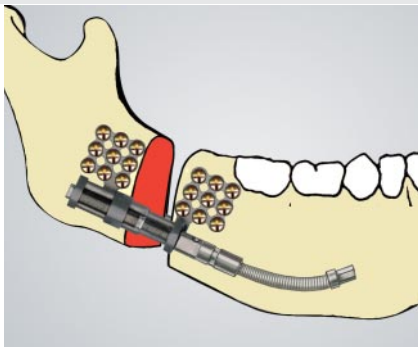
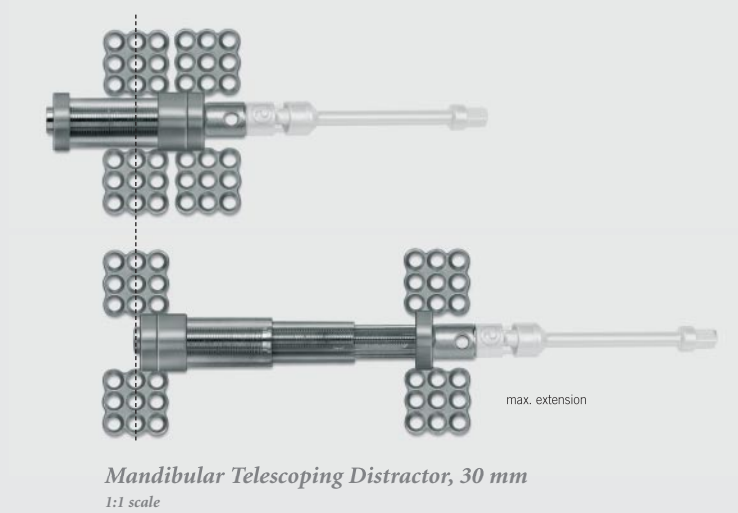

Mandibular Telescoping Distractor



Mandibular Telescoping Distractor

Distractors w/o activators	Item Number
20 mm	51-350-20-09
30 mm	51-350-30-09

TopSeller

Distraction length/turn 0.3 mm

Activators
See pages
40 - 43

Recommended screws

1.5 x 4 mm to 1.5 x 7 mm

Emergency: 1.8 x 5 mm

Drill-Free: 1.5 x 5 mm

Patient screwdrivers

Straight	51-555-85-07
Angled	51-555-95-07

Using intraoral distractors for the therapy of serious mandibular micrognathias or asymmetries poses the basic problem of how to accommodate the relatively large spindle of the distractor in the patient's mouth.

The telescopic mandibular distractor provides the solution. Just like a car antenna, this distractor extends continuously in various phases, reaching its full volume only at the end of the distraction process.

Mandibular Distraction

Ramus Transport Distractor

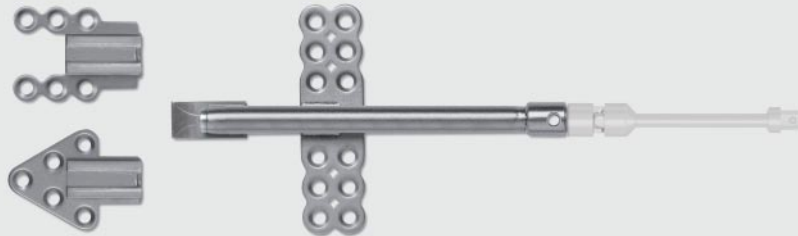

51-421-20-09



51-422-12-09

Ramus Transport Distractor

1:1 scale

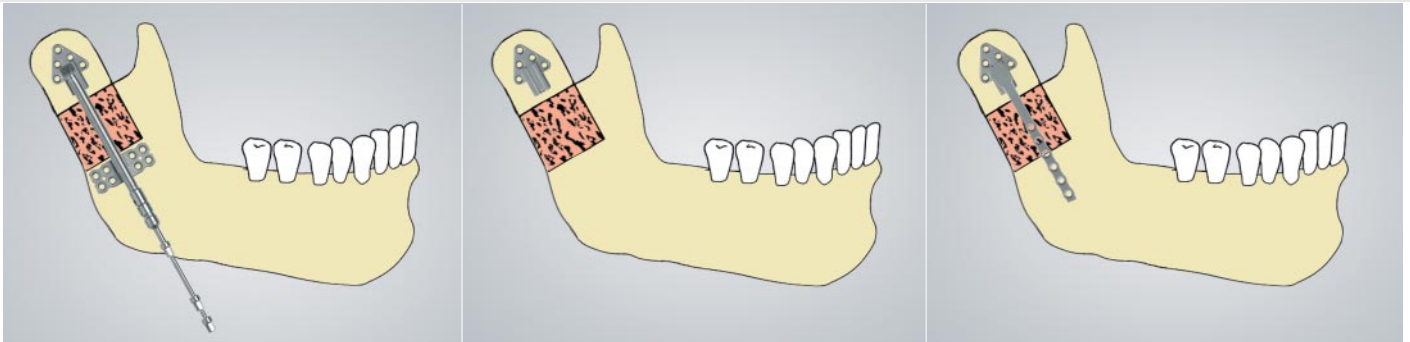

Ramus Transport Distractors

Ramus Transport Distractors

End-driven distractors w/o activators	Item Number
20 mm	51-421-20-09
25 mm TopSeller	51-421-25-09
30 mm	51-421-30-09
Distraction length/turn 0.5 mm	
To order separately	
Consolidation plate	51-422-12-09

Activators
See pages
40 - 43

Recommended screws
1.5 x 3.5 mm to 1.5 x 7 mm
Emergency: 1.8 x 5 mm
Drill-Free: 1.5 x 5 mm

Patient screwdrivers
Straight 51-500-90-07



51-500-90-07

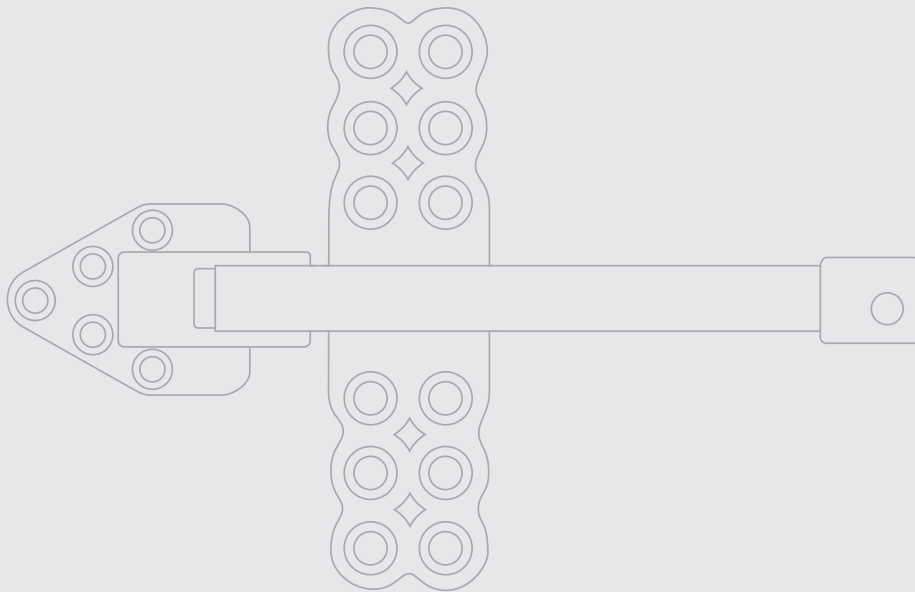

Transport distraction of the condylar head represents an interesting therapeutic option for the surgical correction of mandibular joint ankylosis and improvement of oral opening.

An L-type posterior ramus osteotomy provides for targeted movability to the condyle and enables isolated osteogenesis of the respective bone structures. The distractor has a completely symmetrical design and therefore can be used on both sides.

Thanks to the availability and modular use of activators (see pages 40-43), together with the two alternative posterior attachments provided, the surgeon can respond flexibly and individually to any anatomical challenge.

A special retention plate (51-422-12-09) is optionally available for increased patient convenience during the consolidation phase.

In case of using the retention plate, the distractor is detached from the posterior plate and removed. The retention plate is then attached from the front (caudally) and firmly locked in place. The posterior plate remains firmly connected to the condyle at any time.

Mandibular Distraction

Zurich Wood Distractor

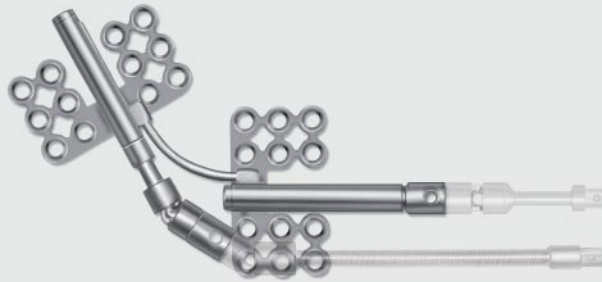

Zurich Wood Distractor
1:1 scale

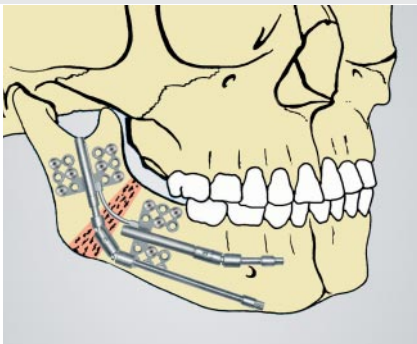

Zurich Wood Distractor

Zurich Wood Distractor

Distractors w/o activators	Item Number
10 x 15 mm, left	51-300-15-09
20 x 20 mm, left	51-300-20-09
10 x 15 mm, right	51-301-15-09
20 x 20 mm, right	51-301-20-09
Distraction length/turn 0.5 mm	

Recommended screws
1.5 x 3.5 mm to 1.5 x 7 mm
Emergency: 1.8 x 5 mm
Drill-Free: 1.5 x 5 mm

Patient screwdrivers	
Straight	51-500-90-07
Angled	51-505-90-07
Combination straight and angled for handle 25-402-99-07	51-505-91-04

Activators
See pages
40 - 43

Mandibular micrognathias frequently affect both the mandibular body and the ascending ramus. Bidirectional distractors offer surgeons an opportunity to treat both sectors in a targeted but independent way.

As opinions differ with regard to the question whether single or double osteotomy is indicated in the mandibular angle, the KLS Martin range of distractors offers solutions that satisfy the demands of both parties.

Zurich Wood distractors are a combination of two Zurich distractors. Their design reflects a very frequent type of mandibular micrognathias and asymmetries in which both the mandibular body and the ascending ramus are affected.

However, the entire range of activators contained in the Zurich modular distractor line can be used in addition to supplement or modify the two activators as required.

Zurich Wood distractors require only one osteotomy line to be performed in the mandibular angle region.

Zurich Bidirectional Distractor

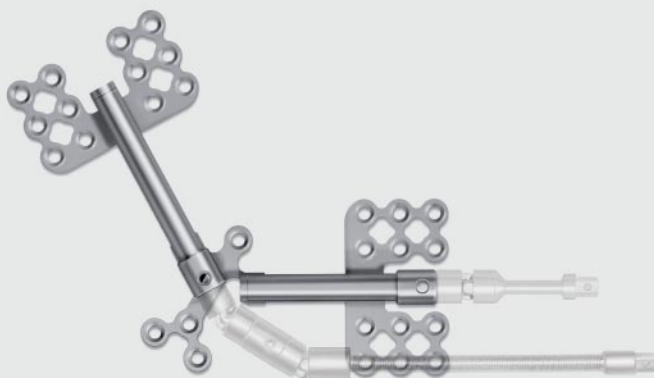

Zurich Bidirectional Distractor

1:1 scale

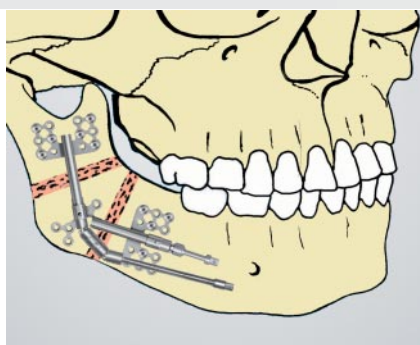

Zurich Bidirectional Distractor

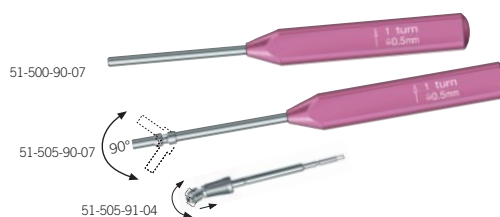

Zurich Bidirectional Distractor

Distractors w/o activators	Item Number
10 x 15 mm, left	51-310-15-09
15 x 20 mm, left	51-310-20-09
10 x 15 mm, right	51-311-15-09
15 x 20 mm, right	51-311-20-09
Distraction length/turn 0.5 mm	

Top Seller

Activators
See pages
40 - 43

Recommended screws

1.5 x 3.5 mm to 1.5 x 7 mm

Emergency: 1.8 x 5 mm

Drill-Free: 1.5 x 5 mm

Patient screwdrivers

Straight	51-500-90-07
Angled	51-505-90-07
Combination straight and angled for handle 25-402-99-07	51-505-91-04

By means of a double osteotomy, the gonial angle will be clearly identified and formed. Individual bone formation of both, the ascending ramus and the mandibular body are guaranteed applying the two different activation spindles.

Mandibular Distraction

ThreadLock Transport Distractor

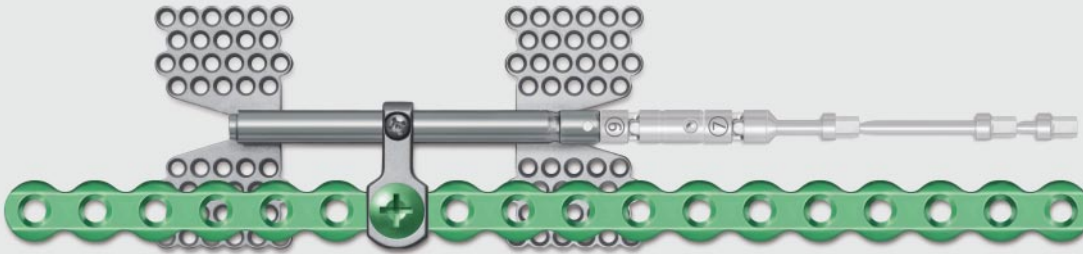

Compatible with the previous ThreadLock as well as the new ThreadLock TS system.

ThreadLock Transport Distractor
fixed on a 2.7-mm ThreadLock TS reconstruction plate
(to be ordered separately)
1:1 scale

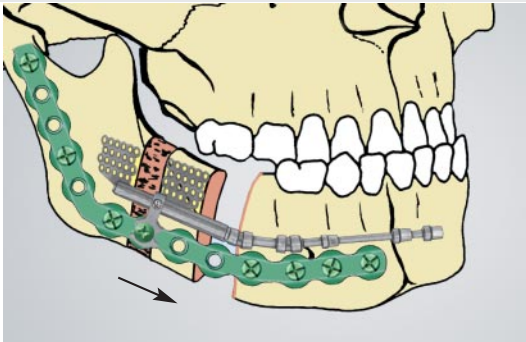

ThreadLock Transport Distractor



ThreadLock Transport Distractor

Distractors w/o activators	Item Number
40 mm	51-700-40-09 *
50 mm	Top Seller 51-700-50-09 *
Distraction length/turn 0.5 mm	

Activators
See pages
40 - 43

Recommended screws
1.5 x 4 mm to 1.5 x 7 mm
Emergency: 1.8 x 5 mm
Drill-Free: 1.5 x 5 mm

Patient screwdrivers	
Straight	51-500-90-07
Angled	51-505-90-07
Combination straight and angled for handle 25-402-99-07	51-505-91-04

* including
1x distractor incl. the following fixation screws
① 1x Centre Drive® fixing screw 2.7 x 6 mm for ThreadLock recon plates (2.7 mm)
② 1x Cross Drive fixing screw 2.7 x 6 mm for ThreadLock recon plates (2.7 mm)
③ 1x Cross Drive fixing screw 2.7 x 6 mm for ThreadLock recon plates (2.7 mm)
④ 1x maxDrive® fixing screw 2.7 x 6 mm for ThreadLock recon plates (2.7 mm)



For additional product information, please refer to the brochure "The ThreadLock Transport Distractor".

Herford Transport Distractor

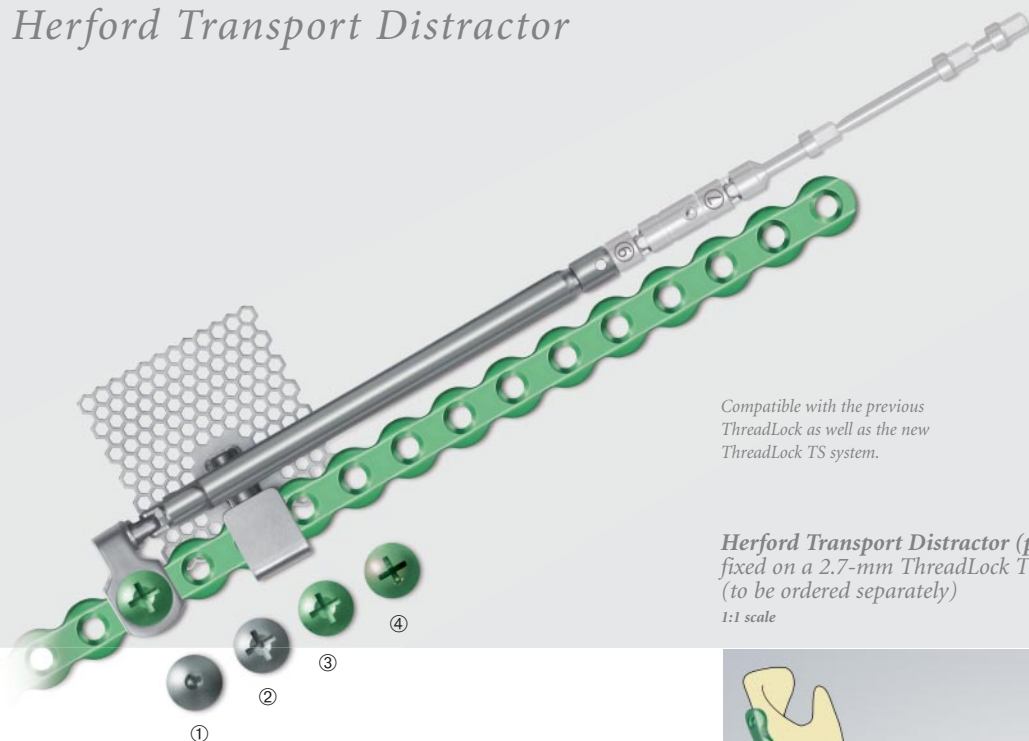

Compatible with the previous ThreadLock as well as the new ThreadLock TS system.

Herford Transport Distractor (plate guided)
fixed on a 2.7-mm ThreadLock TS reconstruction plate
(to be ordered separately)

1:1 scale

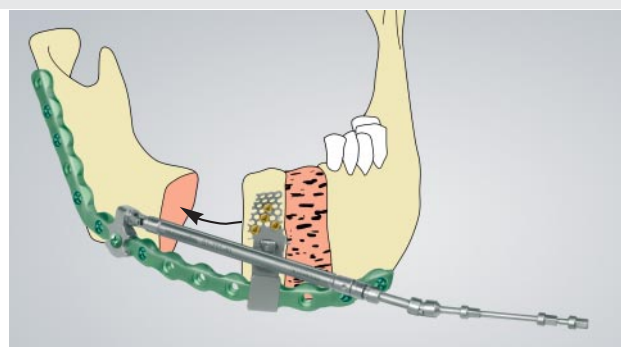

Herford Transport Distractor (plate guided)

Herford Transport Distractor (plate guided)

Distractors w/o activators	Item Number
40 mm, left	51-710-40-09 *
50 mm, left	51-710-50-09 *
60 mm, left	51-710-60-09 *
40 mm, right	51-711-40-09 *
50 mm, right	51-711-50-09 *
60 mm, right	51-711-60-09 *

Top Seller

Activators
See pages
40 - 43

Distraction length/turn 0.5 mm

Recommended screws

1.5 x 4 mm to 1.5 x 7 mm
Emergency: 1.8 x 5 mm
Drill-Free: 1.5 x 5 mm

Patient screwdrivers

Straight	51-500-90-07
Angled	51-505-90-07
Combination straight and angled for handle	25-402-99-07 51-505-91-04

* including

1x distractor incl. the following fixation screws

- ① 1x Centre Drive® fixing screw 2.7 x 6 mm for ThreadLock recon plates (2.7 mm)
- ② 1x Cross Drive fixing screw 2.7 x 6 mm for ThreadLock recon plates (2.7 mm)
- ③ 1x Cross Drive fixing screw 2.7 x 6 mm for ThreadLock recon plates (2.7 mm)
- ④ 1x maxDrive® fixing screw 2.7 x 6 mm for ThreadLock recon plates (2.7 mm)



For additional product information on ThreadLock TS, please refer to the brochure "ThreadLock TS – Multidirectional Locking Plate System".

Maxillary Distraction

Zurich Pediatric Maxillary Distractor



Zurich Pediatric Maxillary Distractor
(flexible activator)

1:1 scale



Zurich Pediatric Maxillary Distractor
(with detached activator)

2:1 scale

Zurich Pediatric Maxillary Distractor

Distractors with flexible activators (t* = 0.6 mm) Item Number

15 mm, left	51-550-15-09
15 mm, right	51-551-15-09

Distraction length/turn 0.5 mm

Distractors with rigid activators (t* = 0.6 mm)

15 mm, left	51-552-15-09
15 mm, right	51-553-15-09

Distraction length/turn 0.5 mm

Distractors w/o activators (t* = 1.0 mm)

15 mm, left	51-556-15-09
20 mm, left	51-556-20-09
15 mm, right	51-557-15-09
20 mm, right	51-557-20-09

Distraction length/turn 0.5 mm

Recommended screws

1.5 x 5 mm to 1.5 x 7 mm
Emergency: 1.8 x 5 mm
Drill-Free: 1.5 x 5 mm

Patient screwdrivers

Straight	51-500-90-07
Angled	51-505-90-07
Combination straight and angled for handle 25-402-99-07	51-505-91-04

* thickness of the plate

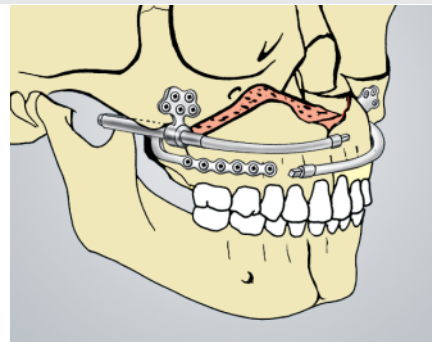

Zurich Pediatric Maxillary Distractor (flexible activator)

Activators
See pages
40 - 43

Maxillary Telescoping Distractor

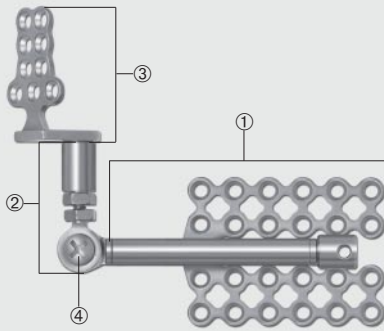

Adjustable Maxillary Distractor, 15 mm
1:1 scale

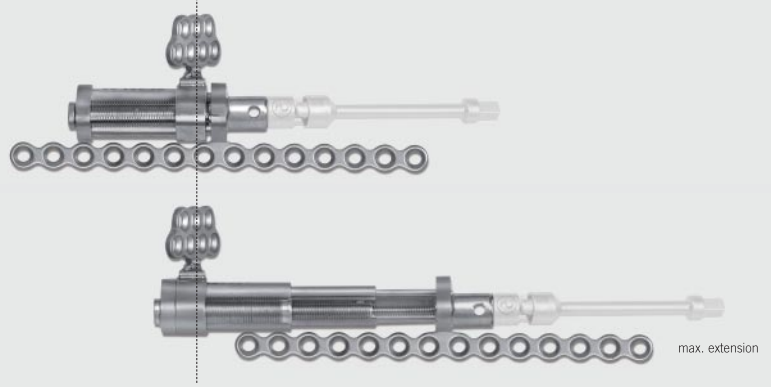

Maxillary Telescoping Distractor, 30 mm, right
1:1 scale

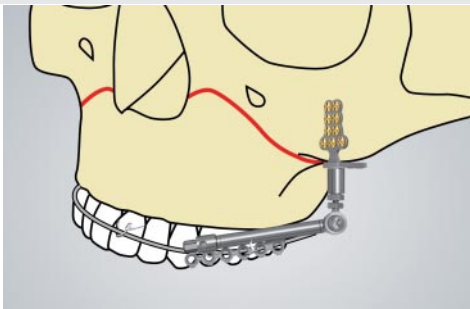

Adjustable Maxillary Distractor

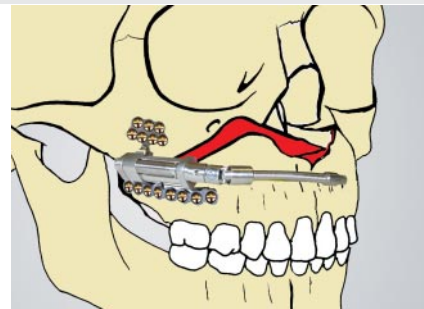

Maxillary Telescoping Distractor

Adjustable Maxillary Distractor

① Distractors w/o activators	Item Number
10 mm	51-401-10-09
15 mm TopSeller	51-401-15-09
20 mm	51-401-20-09
Distraction length/turn 0.5 mm	
② Vertical adjusting arm	
16 mm	51-402-16-09
20 mm	51-402-20-09
24 mm	51-402-24-09
③ Malar osteosynthesis plate	
2-hole, short	51-401-30-09
3-hole, short	51-401-31-09
2-hole, long	51-401-32-09
④ Fixation screw	
to be fixed with 2.0/2.3-mm maxDrive® blade (25-491-97-07)	
Recommended screws*	
1.5 x 5 mm to 1.5 x 7 mm	
Emergency: 1.8 x 5 mm	
Drill-Free: 1.5 x 5 mm	
Patient screwdrivers	
Straight	51-500-90-07
Angled	51-505-90-07
Wrench for vertical adjusting arm	
Wrench	51-401-40-07

Activators
See pages
40 - 43

Maxillary Telescoping Distractor

Distractors w/o activators	Item Number
20 mm, left	51-360-20-09
30 mm, left	51-360-30-09
20 mm, right	51-361-20-09
30 mm, right TopSeller	51-361-30-09
Distraction length/turn 0.3 mm	
Recommended screws	
1.5 x 4 mm to 1.5 x 7 mm	
Emergency: 1.8 x 5 mm	
Drill-Free: 1.5 x 5 mm	
Patient screwdrivers	
Straight	51-555-85-07
Angled	51-555-95-07



* As an alternative to the bone-borne fixation with screws, the horizontal distractor body can be fixed to an intraoral acrylic splint or to a tooth-borne metal splint.

Maxillary Distraction

TS-MD Distractor



TS-MD Distractor
1:1 scale

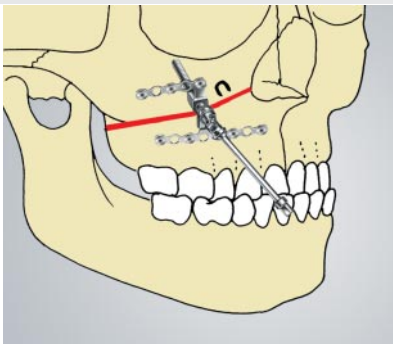

TS-MD Distractor



TS-MD Distractor

Distractors incl. activator	Item Number
20 mm TopSeller	51-540-20-09
25 mm	51-540-25-09
30 mm	51-540-30-09
Distraction length/turn 0.5 mm	

Recommended screws	
1.5 x 3.5 mm to 1.5 x 7 mm	
Emergency: 1.8 x 5 mm	
Drill-Free: 1.5 x 5 mm	

Patient screwdrivers	
Straight	51-500-90-07
Angled	51-505-90-07
Combination straight and angled for handle 25-402-99-07	51-505-91-04

The TS-MD distractor is designed for the treatment of moderate to severe maxillary deficiency and hypoplasia in children and adolescents.

The distraction spindle is placed in the maxillary sinus which is large enough even at the age of 6 to 8 years to provide room for it. The anatomy of the maxillary sinus causes no limitation in the choice of the vector of distraction, which is indicated by the position of the distraction spindle.



For additional product information, please refer to the brochure "Antwerp Trans-Sinusoidal Maxillary Distractor (TS-MD)".

Liou Cleft Distractor



Liou Cleft Distractor

1:1 scale

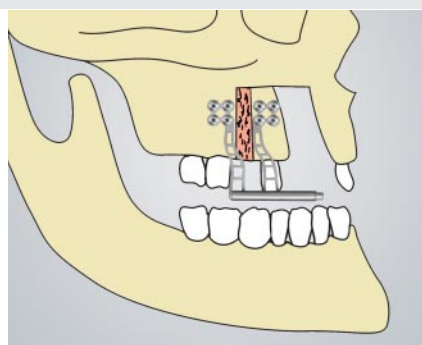
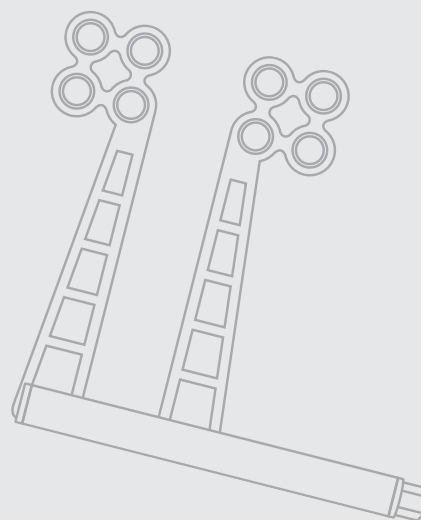

Liou Cleft Distractor



Liou Cleft Distractor

Distractors	Item Number
20 mm, left	51-650-20-09
20 mm, right	51-651-20-09

Distraction length/turn 0.3 mm

Recommended screws
1.5 x 4 mm or 1.5 x 5 mm
Emergency: 1.8 x 5 mm
Drill-Free: 1.5 x 5 mm

Patient screwdrivers	Item Number
Straight	51-525-85-07
Combination straight and angled	51-525-90-07
Combination straight and angled for handle 25-402-99-07	51-525-91-04

The Liou Cleft Distractor is an intraoral system for the horizontal transport distraction of the maxillary alveolar ridge. The distractor allows segment transport in unidirectional way, enabling reconstruction of defects resulting from:

- alveolar cleft in cleft lip and palate patients
- removal of alveolar fistula
- congenital or acquired deficiency of the alveolar ridge

Note:
For all Liou Cleft Distractors, no activator is needed.

Transverse Maxillary Distraction

Rotterdam Palatal Distractor

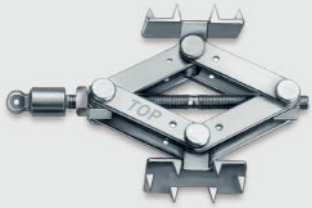
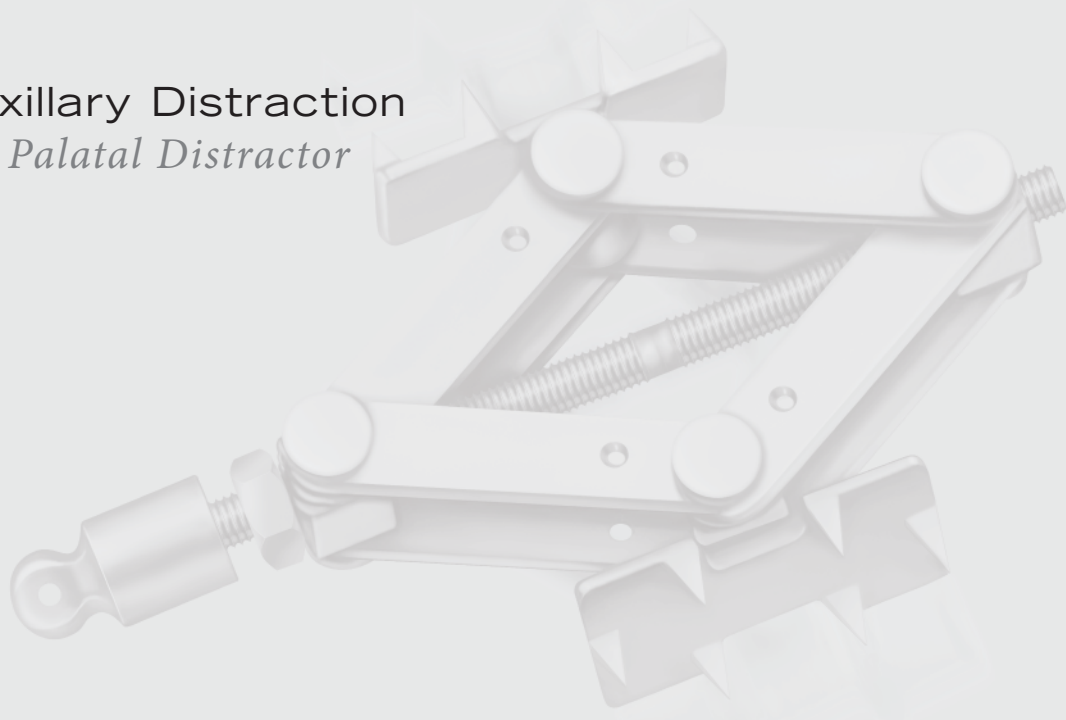

Rotterdam Palatal Distractor
1:1 scale

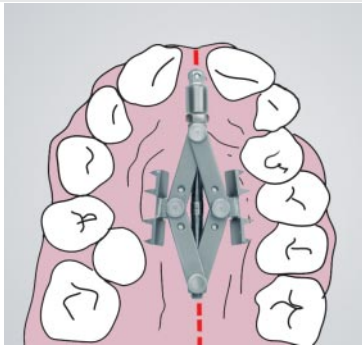

Rotterdam Palatal Distractor, start position

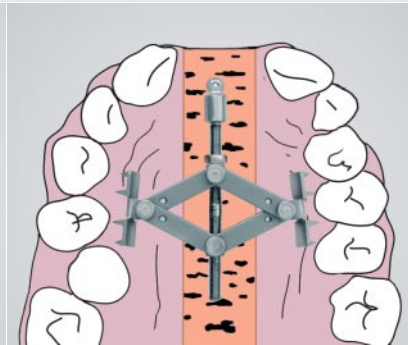

During distraction period



Rotterdam Palatal Distractor

Distractors	Item Number
9 mm initial width (19 mm distraction length)	51-555-09-09 Top Seller
13 mm initial width (19 mm distraction length)	51-555-13-09

Distraction length/turn see distraction diagram

Screws are not required!

Patient screwdrivers

Hockey stick-like	51-555-90-07
Straight	51-555-85-07
Angled	51-555-95-07

Distraction Diagram

showing the width of a 9-mm Rotterdam Palatal Distractor in relation to active distraction time

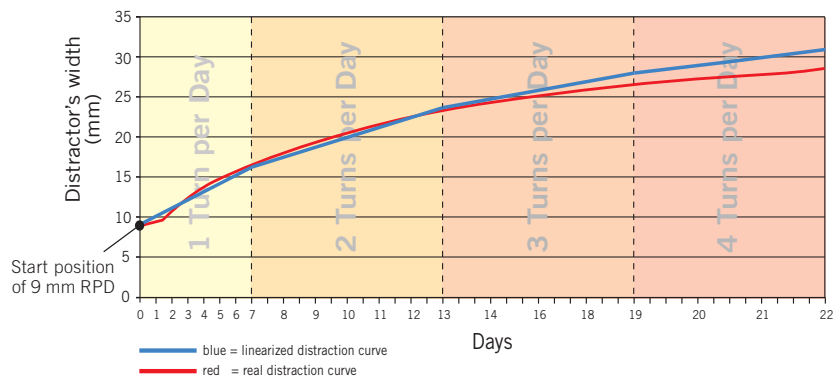

For additional product information, please refer to the brochure "Rotterdam Palatal Distractor".

Rapid Palatal Expander



Rapid Palatal Expanders (RPEs)

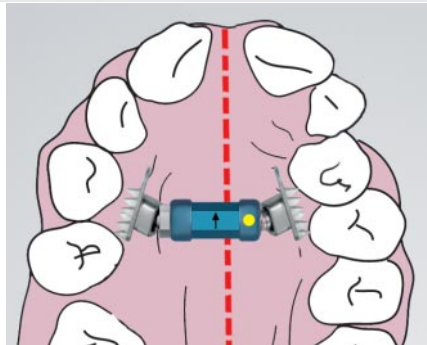

RPE Distractor



51-565-90-07



2 maxDrive® Drill-Free screws
2.0 x 7 mm



Additionally available:
Flexible activating wrench
51-565-95-07

Rapid Palatal Expander (RPE)

Distractors	Item Number	sterileR
① 9 mm distraction length	51-565-09-09*	51-565-09-71**
② 18 mm distraction length TopSeller	51-565-18-09*	51-565-18-71**
③ 27 mm distraction length	51-565-27-09*	51-565-27-71**
④ 36 mm distraction length	51-565-36-09*	51-565-36-71**

Recommended distraction length

1-2 color codes = 0.33 - 0.66 mm/day
(one complete turn = 1.0 mm)

Measuring Templates

Size I	51-564-09-09
Size II	51-564-18-09
Size III	51-564-27-09
Size IV	51-564-36-09

Recommended screws

Drill-Free: 2.0 x 7 mm

Patient screwdriver

Activating wrench	51-565-90-07
Flexible activating wrench	51-565-95-07

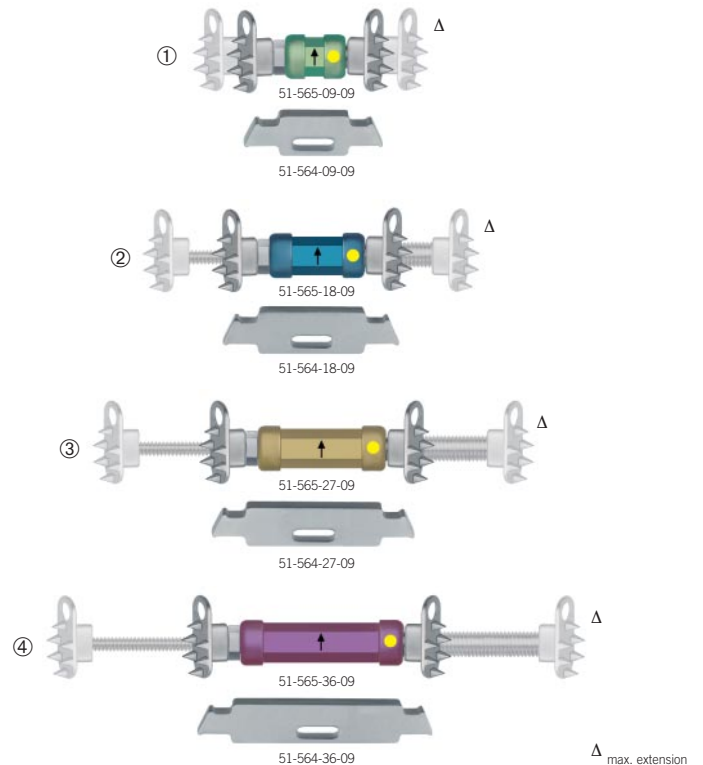

1:1 scale

Δ max. extension

* distractor including activating wrench 51-565-90-07 and 2 maxDrive® Drill-Free screws 2.0 x 7 mm
** sterile packed distractor, including activation wrench 51-565-90-07 and 2 maxDrive® Drill-Free screws 2.0 x 7 mm

Transverse Mandibular Distraction

Rotterdam Midline Distractor



Rotterdam Midline Distractor
1:1 scale

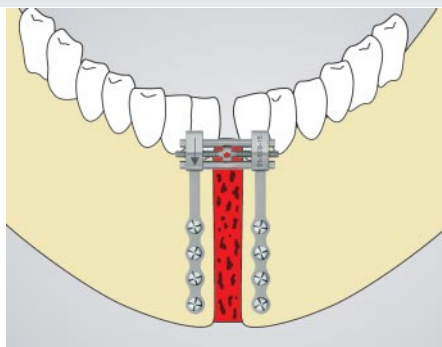

Rotterdam Midline Distractor

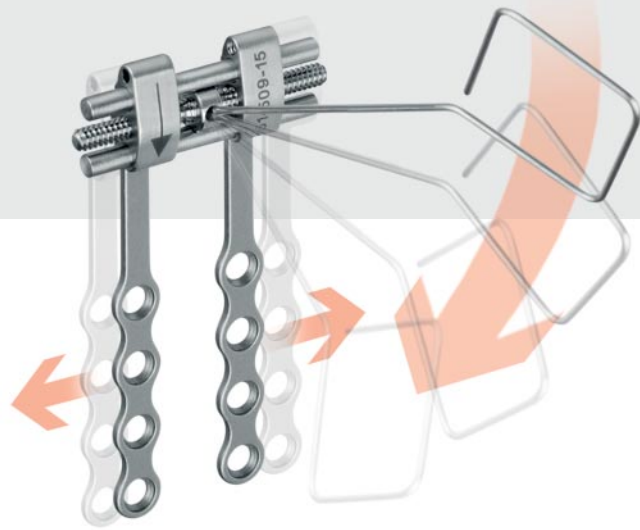

Rotterdam Midline Distractor

Distractors	Item Number
10 mm	51-509-10-09*
15 mm	TopSeller 51-509-15-09*

Recommended distraction length

2 activ. of 90° = 0.5 mm

4 activ. of 90° = 1.0 mm

Recommended screws

2.0 x 4 mm to 2.0 x 11 mm

Emergency: 2.3 x 5, 7, 9 mm

Drill-Free: 2.0 x 5, 7 mm

Patient screwdriver

Activating wire 51-509-90-07

* including activating wire

Transverse mandibular hypoplasia with crowding of the anterior teeth and a V-shape of the mandible is frequently seen in patients with Class I and II malocclusions and Class III patients requiring decompensation before orthognathic surgery. The surgical technique of widening the symphyseal area of the mandible by means of distraction is a successful treatment option for such indications. The Rotterdam Midline Distractor is a totally bone-borne distractor, based on a simple hyrax-appliance, that can easily be placed and activated.



51-509-90-07



For additional product information, please refer to the brochure "Rotterdam Midline Distractor".

Bologna Midline Distractor

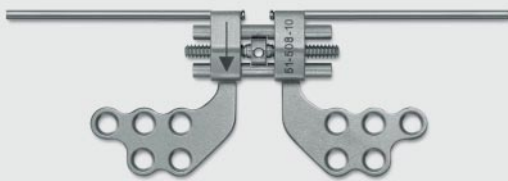

Bologna Midline Distractor
1:1 scale

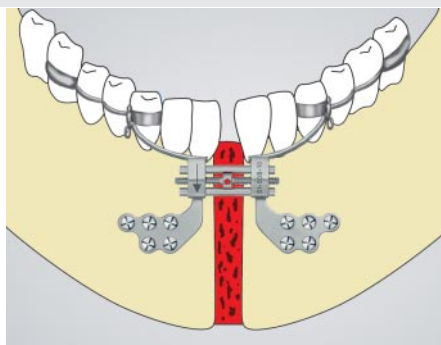
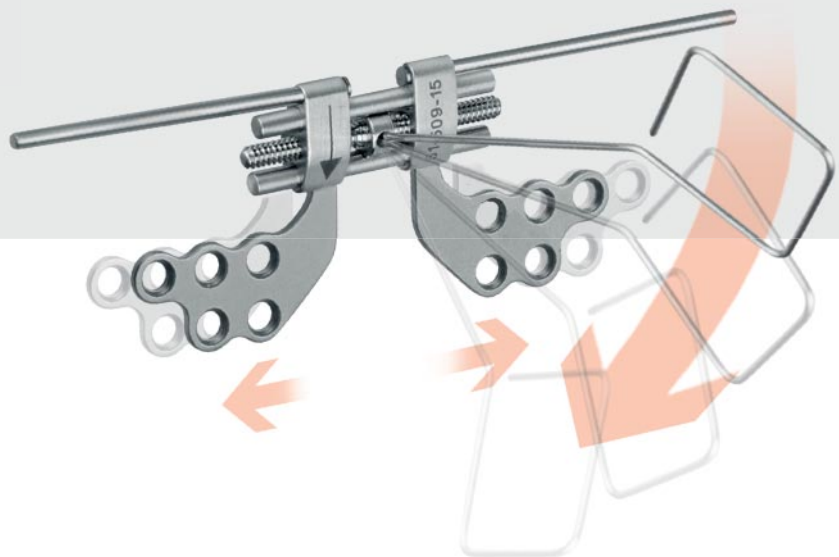

Bologna Midline Distractor

Bologna Midline Distractor

Distractors	Item Number
10 mm	51-508-10-09*
15 mm	TopSeller 51-508-15-09*

Recommended distraction length

2 activ. of 90° = 0.5 mm

4 activ. of 90° = 1.0 mm

Recommended screws

2.0 x 4 mm to 2.0 x 7 mm

Emergency: 2.3 x 5, 7 mm

Drill-Free: 2.0 x 5, 7 mm

Patient screwdriver

Activating wire 51-509-90-07

* including activating wire

The Bologna Midline Distractor offers the combination of bone-borne and tooth-borne anchorage. The attached steel bar enables a stable fixation with the dental anchoring and in this way allows a parallel bone and dental arch widening. Therefore a maximum reliability of force transmittance can be guaranteed.



51-509-90-07



For additional product information, please refer to the brochure "Bologna Midline Distractor".

Midface and Cranial Distraction

Arnaud Cranio-orbital Distractors

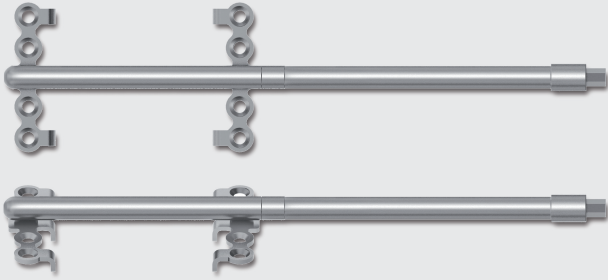

Arnaud Cranio-orbital Distractor 1.5
1:1 scale

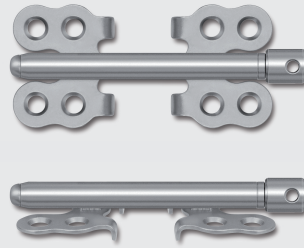

Arnaud Cranio-orbital Distractor 2.0
1:1 scale

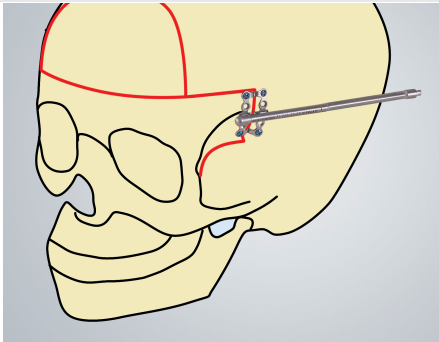

Arnaud Cranio-orbital Distractor 1.5

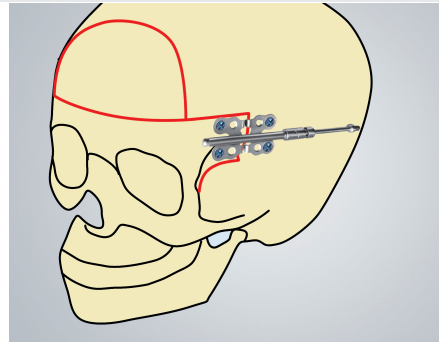

Arnaud Cranio-orbital Distractor 2.0

Arnaud Cranio-orbital Distractor

Arnaud 1.5

Distractor incl. activator	Item Number
20 mm	51-630-20-09
30 mm	51-630-30-09

Distraction length/turn 0.3 mm

Recommended screws	
Standard screws:	1.5 x 3.5 mm to 1.5 x 5 mm
Emergency:	1.8 x 5 mm
Drill-Free:	1.5 x 5 mm

Patient screwdrivers	
Straight 0.3 mm	51-525-85-07
Combination straight and angled for handle 25-402-99-07	51-525-91-04

Arnaud 2.0

Distractor w/o activator	Item Number
20 mm	51-632-20-09
30 mm	51-632-30-09

Distraction length/turn 0.6 mm

Recommended screws	
Standard screws:	2,0 x 4 mm to 2,0 x 5 mm
Emergency:	2,3 x 5 mm
Drill-Free:	2,0 x 5 mm

Patient screwdrivers	
Straight 0,6 mm	51-423-95-07
Combination straight and angled for handle 25-402-99-07	51-505-91-04

Activators
See pages
40 - 43

Marchac Temporal Distractors

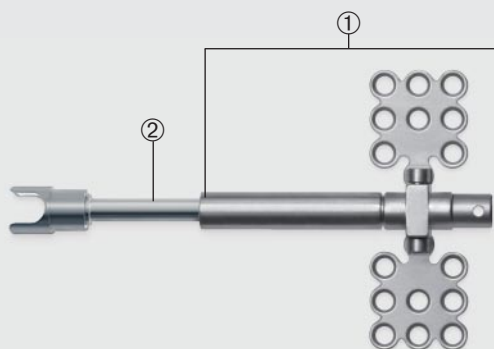

Marchac Temporal Distractor

1:1 scale

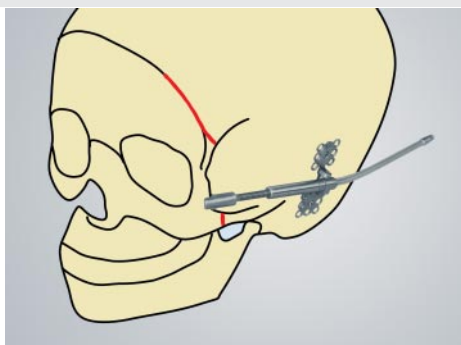

Marchac Temporal Distractor



Marchac Temporal Distractor

① Distractors w/o activators	Item Number
25 mm, for babies	51-620-25-09
35 mm, for children and adults TopSeller	51-620-35-09
Distraction length/turn 0.5 mm	

Activators
See pages
40 - 43

② to order separately	
Spindle incl. pivot, 40 mm	51-623-40-09
Spindle incl. pivot, 50 mm	51-623-50-09
Spindle incl. pivot, 60 mm	51-623-60-09
Spindle incl. pivot, 70 mm	51-623-70-09



For additional product information,
please refer to the brochure
"Arnaud-Marchac Distraction System".

Recommended screws	
1.5 x 3.5 mm to 1.5 x 7 mm	
Emergency: 1.8 x 5 mm	
Drill-Free: 1.5 x 5 mm	

Patient screwdrivers	
Straight	51-500-90-07
Combination straight and angled for handle 25-402-99-07	51-505-91-04

Midface and Cranial Distraction

Kawamoto Distractors

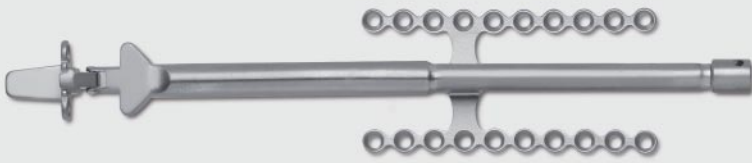

Kawamoto Distractor

1:1 scale

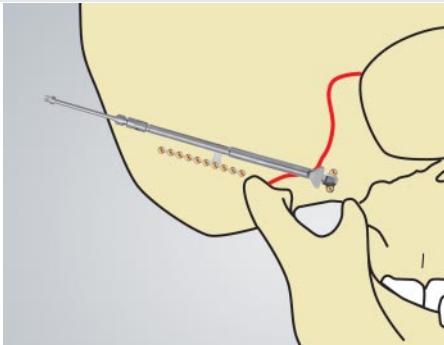

Kawamoto Distractor

Kawamoto Distractor

Distractors w/o activators	Item Number
Straight, 30 mm TopSeller	51-402-30-09
Bent, 30 mm	51-403-30-09
Bent, flat, type Urata, 30mm	51-541-30-09
Distraction length/turn 0.5 mm	

Activators
See pages
40 - 43

Recommended screws	
Standard screws:	1.5 x 3.5 mm to 1.5 x 5 mm
Emergency:	1.8 x 5 mm
Drill-Free:	1.5 x 5 mm

Patient screwdrivers	
Straight 0.5 mm	51-500-90-07
Angled 0.5 mm	51-505-90-07
Combination straight and angled for handle 25-402-99-07	51-505-91-04

Posterior Cranial Vault Distractors

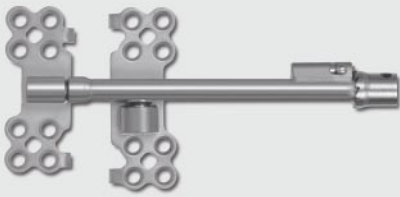

Posterior Cranial Vault Distractor
1:1 scale

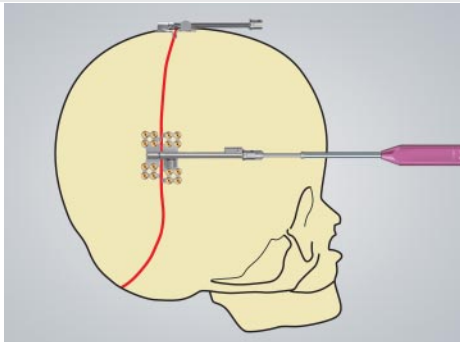

Posterior Cranial Vault Distractors

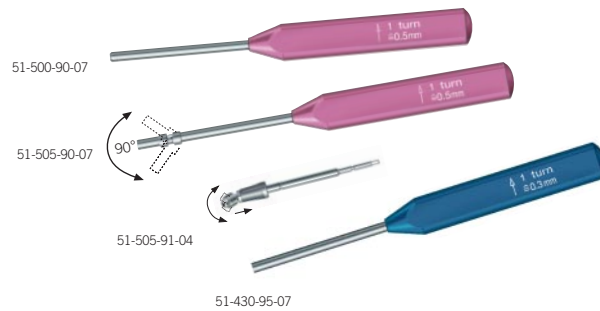

Posterior Cranial Vault Distractor

Distractors w/o activators	Item Number
Small spindle, 30 mm, with ratchet	51-405-42-09
Distraction length/turn 0.3 mm	

TopSeller

Activators
See pages
40 - 43

Distractors w/o activators	Item Number
Large spindle, 30 mm, with ratchet	51-563-30-09
Distraction length/turn 0.5 mm	

Recommended screws	
Standard screws:	1.5 x 3.5 mm to 1.5 x 5 mm
Emergency:	1.8 x 5 mm
Drill-Free:	1.5 x 5 mm

Patient screwdrivers	
Straight 0.3 mm	51-430-95-07
Straight 0.5 mm	51-500-90-07
Angled 0.5 mm	51-505-90-07
Combination straight and angled for handle 25-402-99-07	51-505-91-04

The Posterior Cranial Vault Distractor is especially designed for the distraction of the posterior part of the skull. For optimal adaptation to the convex cranium, the osteosynthesis plates are not fully rigidly attached to the slide but are slightly movable.

External Mandibular Distraction

3D Xternal Distractor



3D Xternal Distraction System
reduced illustration

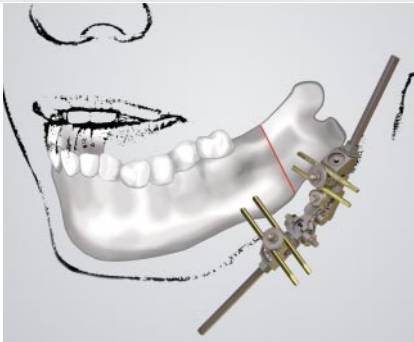

Multidirectional distraction

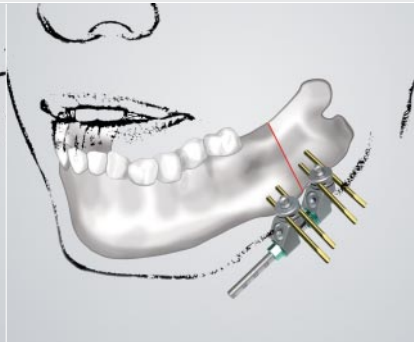

Unidirectional distraction

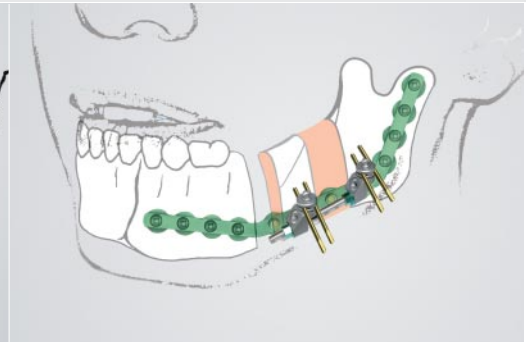

Transport distraction

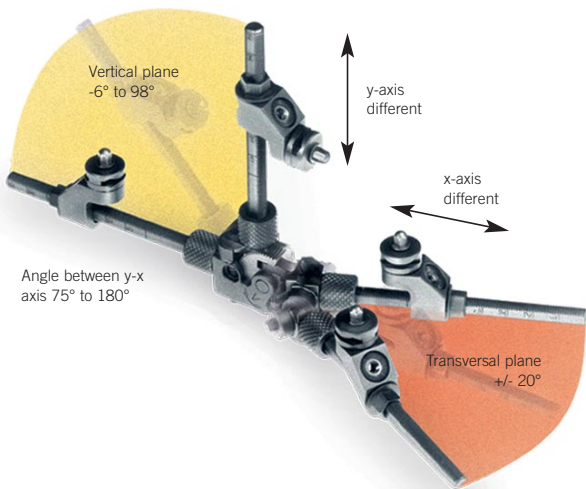

3D Xternal Distraction System

3D X basic set TopSeller **51-601-00-09**
Distraction length/turn 0.5 mm

to order separately	
Pin 2.0 x 50 mm, steel (4 each)	51-620-50-05
Pin 2.7 x 60 mm, steel (4 each)	51-627-60-05
Pin 2.0 x 40 mm, titanium (2 each)	51-606-40-09
Pin 2.7 x 60 mm, titanium (2 each)	51-608-60-09

Instruments	
Patient screwdriver, hexagonal	51-600-75-07
Angular adjustment driver	51-600-80-07
Pin driver	51-600-85-07

For additional product information, please refer to the brochure "3D Xternal Distraction System".

Molina Distractors

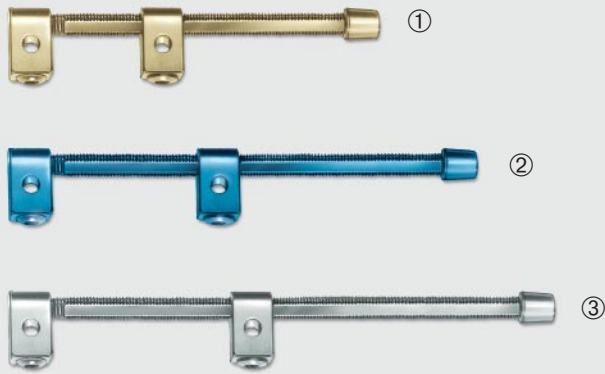

Molina Unidirectional Distractors
1:1 scale

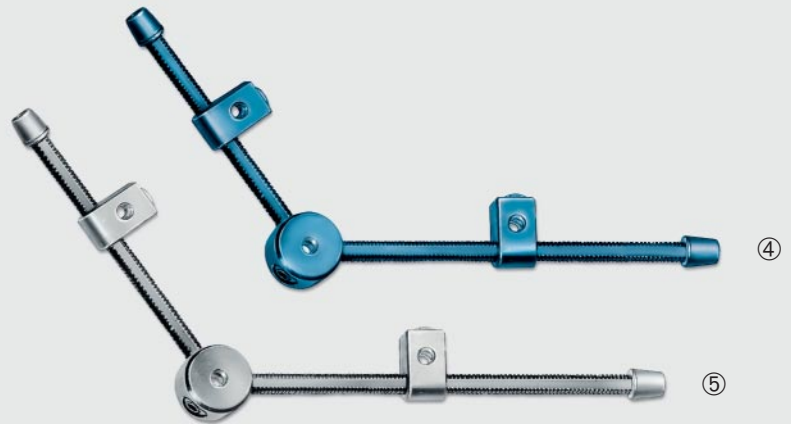

Molina Bidirectional Distractors
1:1 scale

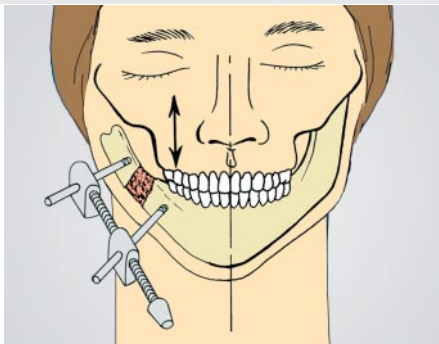

Molina Unidirectional Distractor

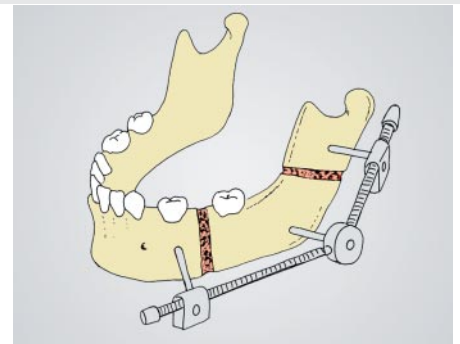
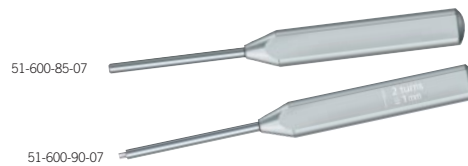

Molina Bidirectional Distractor

Molina Unidirectional Distractor

① Distractor for babies and infants	Item Number
28 mm	51-600-28-09 TopSeller
Distraction length/turn 0.5 mm	
to order separately	
Pins, 2 x 40 mm (2 each)	51-606-40-09
Pin, 2 x 120 mm (1 each)	51-606-12-09
Pins, 2.7 x 60 mm (2 each)	51-608-60-09

② Distractor for children	Item Number
43 mm	51-600-43-09
Distraction length/turn 0.5 mm	
to order separately	
Pins, 2.7 x 60 mm (2 each)	51-608-60-09

③ Distractor for adults	Item Number
53 mm	51-600-53-09
Distraction length/turn 0.5 mm	
to order separately	
Pins, 3.2 x 60 mm (2 each)	51-610-60-09

Patient screwdrivers

Screwdriver for pins	51-600-85-07
Activator and fixation-SD	51-600-90-07

Molina Bidirectional Distractor

④ Distractors for children	Item Number
56 x 40 mm, left	51-601-56-09
56 x 40 mm, right	51-602-56-09
Distraction length/turn 0.5 mm	
to order separately	
Pins, 2.7 x 60 mm (2 each)	51-608-60-09

⑤ Distractors for adults	Item Number
76 x 40 mm, left	51-601-76-09
76 x 40 mm, right	51-602-76-09
Distraction length/turn 0.5 mm	
to order separately	
Pins, 3.2 x 60 mm (2 each)	51-610-60-09

Patient screwdrivers

Screwdriver for pins	51-600-85-07
Activator and fixation-SD	51-600-90-07



For additional product information, please refer to the brochure "Molina Osteo Distraction Systems".

External Midface Distraction

RED II System

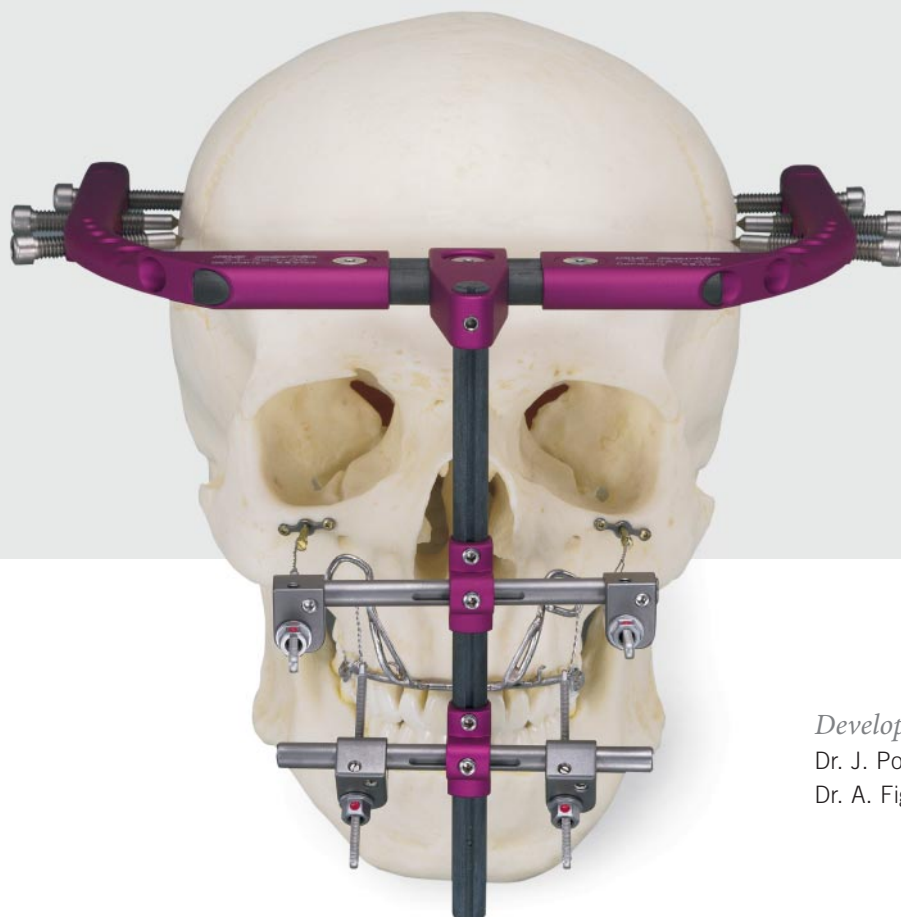

*Developed in cooperation with
Dr. J. Polley, M.D. and
Dr. A. Figueroa, D.D.S., M.S.*

Benefits

Most patients showing midfacial hypoplasia are usually preoperated. Often, a large amount of scar tissue formation is limiting the success of any distraction procedure ending up in compromising results. In these cases, the RED II is definitely setting new standards. It is extremely efficient in bringing the bone segments in the desired position and simultaneously to keep them there for bone consolidation. As all important components are external, the distraction vector can be altered or corrected at any time. A wide selection of accessories is at your disposition to match any clinical task.

- Completely adjustable for any midfacial hypoplasia patient
- Possibility to perform Le-Fort-I, II, III and monobloc distraction procedures
- Force application only on the affected treatment region
- External distractor – easy definition and correction of all vectors at any time
- Unlimited distraction distances
- Very strong distraction force, excellent retention potential
- Easy and quick assembly in the OR as well as removal in the office or clinical setting
- Ability to treat patients with severe skeletal deficiencies who are not amenable to, or would receive comprised results with conventional orthognathic surgery
- No bone grafting required – no uncalculable recidiva involved.

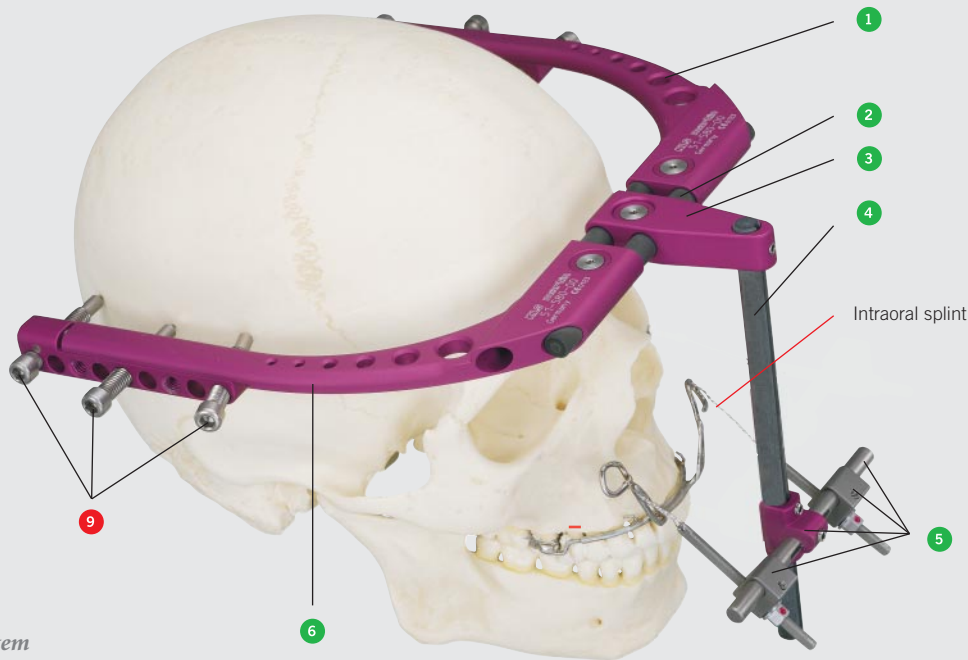

RED II System
reduced illustration

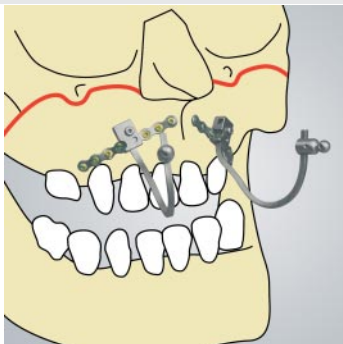

Leipzig Retention Plate in situ

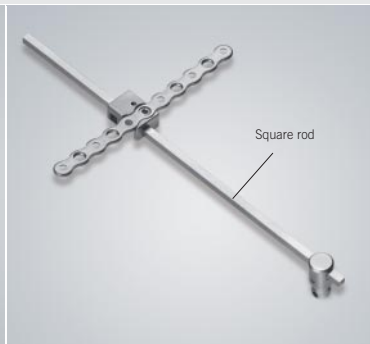

Leipzig Retention Plate



RED II System

Item No.	Qty.	Description
51-580-00-04		RED II Distraction system, complete assembly (prepared for LeFort I procedures)

TopSeller

Consisting of:

1	51-580-01-04	1	Distraction segment, left
2	51-575-15-04	2	Carbon rods, 120 mm, horizontal
3	51-580-05-04	1	Center part
4	51-575-16-04	1	Carbon rod, 150 mm, vertical
5	51-580-45-04	1	Horizontal cross bar assembly, complete with horizontal cross bar + holder + 2 spindle units
6	51-580-02-04	1	Distraction segment, right
7	51-580-85-07	1	Patient screwdriver

To order separately:

8	51-575-90-07	1	Adjustment screwdriver, hexagonal
9	51-575-10-09	1 Pack	Fixation screws 45 mm, 10/each
	or		
	51-575-12-09	1 Pack	Fixation screws 55 mm, 10/each

The connection to the occlusal level can be achieved by either an intraoral splint (manufactured by the hospital's orthodontic team) or the Leipzig retention plates (2 pieces recommended).

Item No.	Description
51-582-50-04	Retention plate 1.5 (1.5 mm square rod)
51-582-55-04	Retention plate 1.8 (1.8 mm square rod)



For further information on the RED II distractor especially for system preparation for LeFort III and Monobloc procedures, please refer to the brochure "Rigid External Distraction".

The brochure contains many additional components and accessories like e.g. the Leipzig retention plates, REDs in different colors or the adjustable spindle unit.

Distraction Activators











Conventional removable Activators

Most KLS Martin distraction devices are delivered without activator allowing the choice of an individual activator that meets the anatomical requirements of the patient instead of using a predefined one.

This not only allows more flexibility but also leads to an increased patient comfort during the distraction procedure.

The whole range of activators includes rigid and flexible activators in different lengths. These activators can additionally be combined with different cardanic extensions to gain more flexibility.

*Conventional removable activators**

	Activation arms	Item No.
① 	Activation arm, flexible, incl. cardanic element, 30 mm	51-400-30-09
② 	Activation arm, flexible, incl. cardanic element, 40 mm	51-400-40-09
③ 	Activation arm, flexible, incl. cardanic element, 50 mm	51-400-50-09
④ 	Activation arm, rigid, incl. cardanic element, 25 mm	51-401-25-09
⑤ 	Activation arm, rigid, incl. cardanic element, 35 mm	51-401-35-09
⑥ 	Activation arm, rigid, incl. cardanic element, 45 mm	51-401-45-09
⑦ 	Activation arm, rigid, incl. cardanic element, 50 mm, clipable	51-401-50-09
Additional		Item No.
⑧ 	Direct drive activator	51-401-90-09
⑨ 	Single cardanic extension for activation arm	51-401-91-09
⑩ 	Rigid extension 20 mm for activation arm	51-401-92-09
1/1 	Trocar tip for activation arm	51-401-93-09

* Removal of activator

During the consolidation period – once the active distraction process has been completed – activators are basically no longer needed and a source of inconvenience for the patient.

The activators on this page can easily be removed by using special disconnection forceps (item no. 51-400-01-07, see page 47).



The following example illustrates the principle of combining different activator components:

Zurich II Distractor,
Mesh design, middle-driven

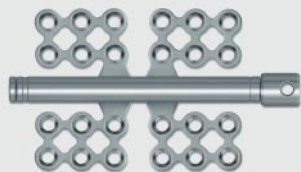

Rigid extension 20 mm
for activation arm



Single cardanic extension
for activation arm



Activation arm, rigid,
incl. cardanic element, 35 mm



Example: Total activator length 61 mm

1:1 scale

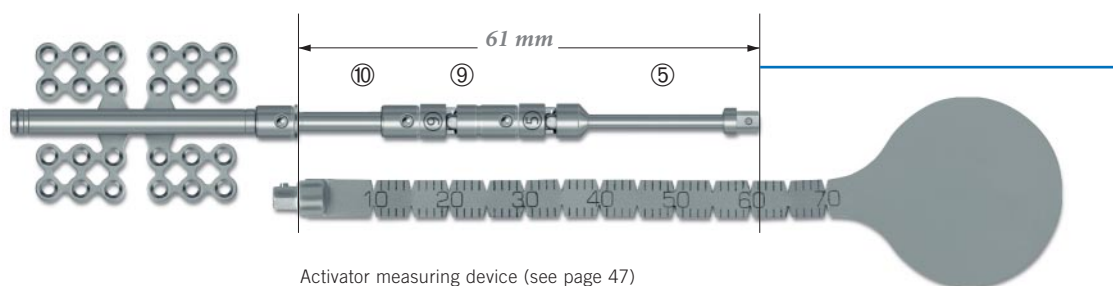

Activator measuring device (see page 47)

Possible combinations

L (mm)	System	L (mm)	System
16	⑧ + ⑨	49	⑤ + ⑩
20	⑧ + ⑩	51	④ + ⑨ + ⑩
22	④	54	② + ⑩
27	①	56	① + ⑨ + ⑩
32	⑤	55	⑥ + ⑨
33	⑧ + ⑨ + ⑩	59	③ + ⑨
35	④ + ⑨	59	⑥ + ⑩
37	②	60	⑦ + ⑨
39	① + ⑨	61	⑤ + ⑨ + ⑩
39	④ + ⑩	64	③ + ⑩
42	⑥	64	⑦ + ⑩
44	① + ⑩	66	② + ⑨ + ⑩
45	⑤ + ⑨	71	⑥ + ⑨ + ⑩
47	⑦	76	③ + ⑨ + ⑩
47	③	77	⑦ + ⑨ + ⑩
49	② + ⑨		



Activation arm
disconnection forceps
51-400-01-07
15.5 cm

Distraction Activators

Remote Release Activators



*Zurich II Distractor,
Mesh design, middle-driven*

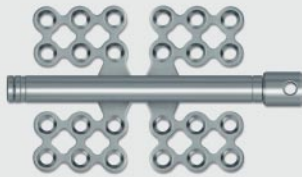

*Example: Activator length 53 mm
1:1 scale*

*Remote Release Activator,
flexible, 53 mm*

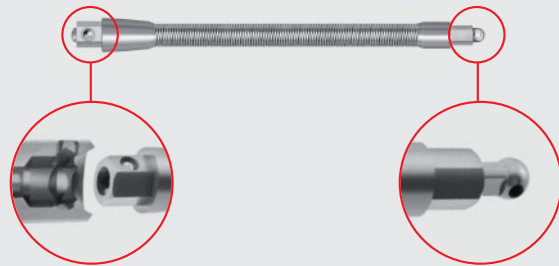

Connection point between
distractor and activator

Point of activation with the
patient screwdriver

During the consolidation phase – once the active distraction process has been completed – distraction activators are basically no longer needed. Quite the contrary, they are not only a constant source of inconvenience to the patient but also involve elevated risk of infection right at the percutaneous point. Conventional distraction activators are disconnected from the distractor body with the aid of special forceps. This usually requires that the operation situs has to be opened again to access the connection point between distractor and activator. Mainly in difficult accessible anatomical regions this can be both time-consuming and difficult and moreover the patient is exposed to additional stress.

Especially for such cases we developed an alternative, a new generation of activators:

The Remote Release Activators.

The special and completely new feature about these activators is that the mechanism of coupling and uncoupling is located at the point of activation with the patient screwdriver.

Thereby the uncoupling of the activator can be initiated directly from the outside and the dissection of the way to the connection point between distractor and activator is not applicable anymore.

Remote Release Activators fit to all standard couplings that are designed for removable activators, such as almost all distractors specified in this brochure. They provide an alternative option in addition to the proven, conventional activators. As standard Remote Release Activators are provided without cardanic element, they may be combined with the cardanic element 51-401-91-09. If one chooses an additional cardanic element, it will stay with the distractor after removal of the Remote Release Activator.

Uncoupling procedure



1. Pull out the release lug (some resistance needs to be overcome).



2. The release lug stands in exposed position by turning it clockwise or anti-clockwise by 90°.



3. This lowers the ball and socket of the universal coupling of the activator.

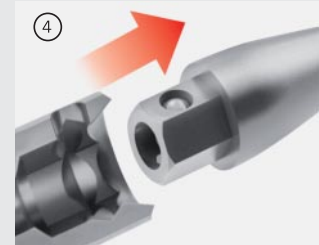





4. The activator can now be easily removed.

Coupling procedure

The coupling procedure is exactly the same up to step 3. Once the ball and socket is lowered, the activator can be easily plugged in place. To lock it, rotate the release lug back by 90° and push it in. This causes the internal ball to rise, thus locking the activator in place.

Remote Release Activators

	Activators	Item No.
	Remote Release Activator, flexible, 33 mm	51-411-33-09
	Remote Release Activator, rigid, 33 mm	51-410-33-09
	Remote Release Activator, rigid, 43 mm	51-410-43-09
	Remote Release Activator, rigid, 53 mm	51-410-53-09
	Single cardanic extension for activation arm	51-401-91-09

Each Remote Release Activator comes with a dedicated instruction for use providing all important information for handling the device.

Instruments for *Distractor Placement*

1.0 mm Micro

(For all distractors fixed with 1.0-mm screws)



*Plate-holding
forceps, curved*
51-525-80-07
15.5 cm

*Plate-holding
instrument*
25-435-10-07
16 cm

1.5 mm Micro

(For all distractors fixed with 1.5-mm screws)



*Plate-holding
forceps, curved*
25-441-16-07
18 cm

*Plate-holding
instrument*
25-435-15-07
18 cm

*Activation arm
disconnection forceps*
51-400-01-07
15.5 cm

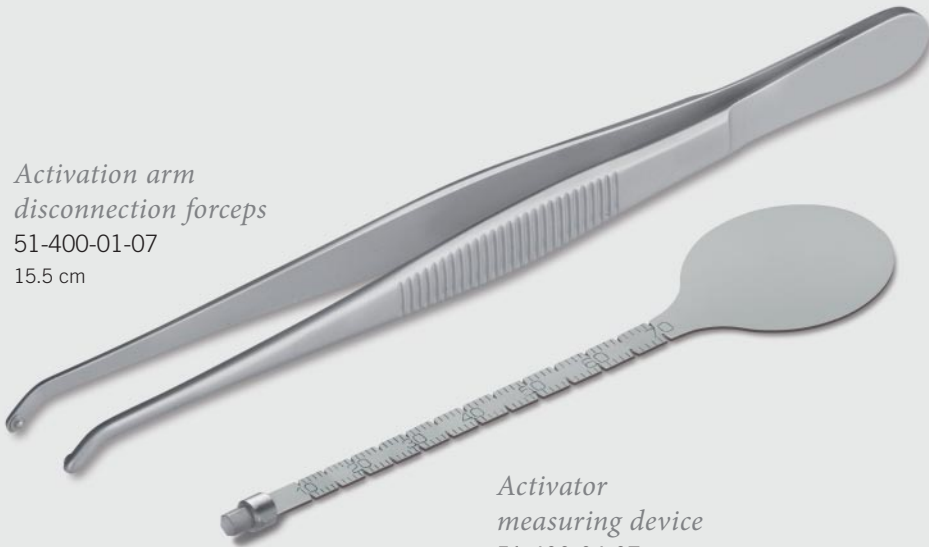

*Activator
measuring device*
51-400-04-07
10.5 cm

Icon explanations

TC GOLD Instruments with tungsten carbide inserts

For both sizes

TC GOLD



*Modeling
pliers*
25-486-13-07
13 cm
2 items recommended



*Body holding
forceps*
51-400-03-07
15.5 cm



*Plate
cutter*
51-400-02-07
18 cm



*Activator
measuring device*
51-400-04-07
10.5 cm



*Activation arm
disconnection forceps*
51-400-01-07
15.5 cm

Screws, Drill Bits and Screwdriver Blades

Centre Drive® 1.0 mm

Micro Screws self-retaining

	Ø x Length	Centre Drive®
	1.0 x 3 mm	25-660-03-09
	1.0 x 4 mm	25-660-04-09
	1.0 x 5 mm	25-660-05-09
	1.0 x 6 mm	25-660-06-09
	1.0 x 7 mm	25-660-07-09

Emergency Screws self-retaining

	Ø x Length	Centre Drive®
	1.2 x 3 mm	25-661-03-09
	1.2 x 5 mm	25-661-05-09

Screwdriver blades for 1.0-mm screws for screwdriver handle 25-402-99-07

	Centre Drive®	
	25-428-98-07	

Drill bits for 1.0-mm screws with J-notch attachment

	Ø x Length	Stop	Item No.
	0.7 x 50 mm	3 mm	25-454-03-91
	0.7 x 50 mm	5 mm	25-454-05-91
	0.7 x 50 mm	7 mm	25-454-07-91

Centre Drive® 1.5 mm

Micro Screws self-retaining

	Ø x Length	Centre Drive®
	1.5 x 3.5 mm	25-665-03-09
	1.5 x 4 mm	25-665-04-09
	1.5 x 5 mm	25-665-05-09
	1.5 x 6 mm	25-665-06-09
	1.5 x 7 mm	25-665-07-09

Emergency Screws self-retaining

	Ø x Length	Centre Drive®
	1.8 x 3.5 mm	25-666-03-09
	1.8 x 5 mm	25-666-05-09
	1.8 x 7 mm	25-666-07-09

Drill-Free-Screws self-retaining

	Ø x Length	Centre Drive®
	1.5 x 4 mm	25-668-04-09
	1.5 x 5 mm	25-668-05-09
	1.5 x 6 mm	25-668-06-09
	1.5 x 7 mm	25-668-07-09

Screwdriver blades for 1.5-mm screws for screwdriver handle 25-402-99-07

	Centre Drive®	maxDrive®
	25-430-98-07	25-489-97-07

maxDrive® 1.5 mm

Micro Screws self-retaining

	Ø x Length	maxDrive®
	1.5 x 3.5 mm	25-875-03-09
	1.5 x 4 mm	25-875-04-09
	1.5 x 5 mm	25-875-05-09
	1.5 x 6 mm	25-875-06-09
	1.5 x 7 mm	25-875-07-09

Emergency Screws self-retaining

	Ø x Length	maxDrive®
	1.8 x 3.5 mm	25-876-03-09
	1.8 x 4 mm	25-876-04-09
	1.8 x 5 mm	25-876-05-09
	1.8 x 7 mm	25-876-07-09

Drill-Free-Screws self-retaining

	Ø x Length	maxDrive®
	1.5 x 4 mm	25-878-04-09
	1.5 x 5 mm	25-878-05-09
	1.5 x 6 mm	25-878-06-09
	1.5 x 7 mm	25-878-07-09

Drill bits for 1.5-mm screws with J-notch attachment

	Ø x Length	Stop	Item No.
	1.1 x 50 mm	3.5 mm	25-452-03-91
	1.1 x 50 mm	5 mm	25-452-05-91
	1.1 x 50 mm	7 mm	25-452-07-91

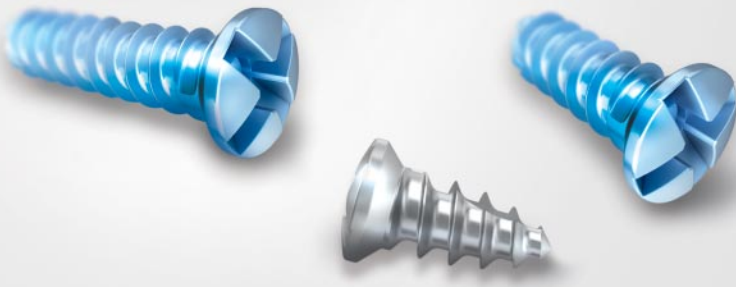

Icon explanations

- St Steel
- Ti Titanium
- 1 Units/pack
- Centre Drive®
- maxDrive®
- J-notch attachment

Centre Drive® 2.0 mm

Mini Screws self-retaining

	Ø x Length	Centre Drive®
	2.0 x 4 mm	25-662-04-09
	2.0 x 5 mm	25-662-05-09
	2.0 x 6 mm	25-662-06-09
	2.0 x 7 mm	25-662-07-09
	2.0 x 9 mm	25-662-09-09
	2.0 x 11 mm	25-662-11-09

maxDrive® 2.0 mm

Mini Screws self-retaining

	Ø x Length	maxDrive®
	2.0 x 4 mm	25-872-04-09
	2.0 x 5 mm	25-872-05-09
	2.0 x 6 mm	25-872-06-09
	2.0 x 7 mm	25-872-07-09
	2.0 x 9 mm	25-872-09-09
	2.0 x 11 mm	25-872-11-09

Emergency Screws self-retaining

	Ø x Length	Centre Drive®
	2.3 x 5 mm	25-663-45-09
	2.3 x 7 mm	25-663-47-09
	2.3 x 9 mm	25-663-49-09

Emergency Screws self-retaining

	Ø x Length	maxDrive®
	2.3 x 4 mm	25-873-44-09
	2.3 x 5 mm	25-873-45-09
	2.3 x 7 mm	25-873-47-09
2.3 x 9 mm	25-873-49-09	

Drill-Free-Screws self-retaining

	Ø x Length	Centre Drive®
	2.0 x 5 mm	25-669-05-09
	2.0 x 7 mm	25-669-07-09

Drill-Free-Screws self-retaining

	Ø x Length	maxDrive®
	2.0 x 5 mm	25-879-05-09
	2.0 x 6 mm	25-879-06-09
	2.0 x 7 mm	25-879-07-09
2.0 x 9 mm	25-879-09-09	

Screwdriver blades for 2.0-mm screws
for screwdriver handle 25-402-99-07

	Centre Drive®	maxDrive®
	25-434-98-07	25-491-97-07

Drill bits for 2.0-mm screws
with J-notch attachment

	Ø x Length	Stop	Item No.
	1.5 x 50 mm	5 mm	25-449-05-91
	1.5 x 50 mm	7 mm	25-449-07-91
	1.5 x 50 mm	9 mm	25-449-09-91
	1.5 x 50 mm	11 mm	25-449-11-91



1/2

25-402-99-07
Screwdriver handle

Instrument for Vector Determination

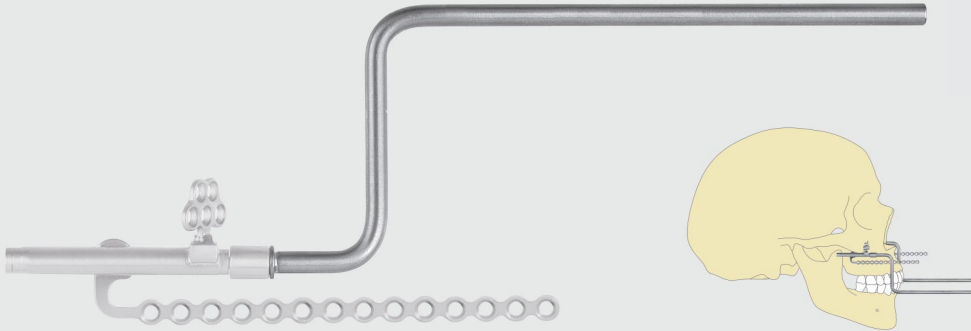

Parallelization instrument

51-400-05-09

(one instrument to be used per distractor)

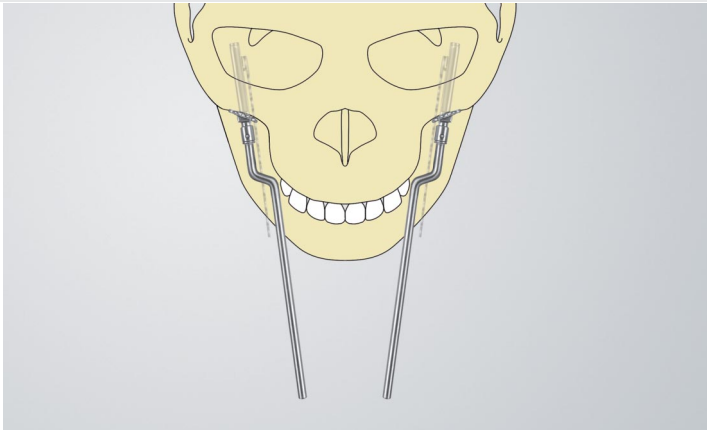

Figure: Problem of vector parallelism: A V-type alignment of 2 distractors can lead to complications, especially where great distraction lengths are involved.

For bilateral distractions in particular, vector parallelism is a factor of great importance. As a rule, both distractors should be aligned as parallel to the distraction vector as possible. Unfortunately, this is easier said than done. The positioning instrument enables users to detect deviations at a very early stage and correct them at once.

The instrument can easily be plugged onto the universal coupling as it is done with an activator.

In this way it greatly facilitates correct distractor alignment, thus helping to prevent complications.

Storage

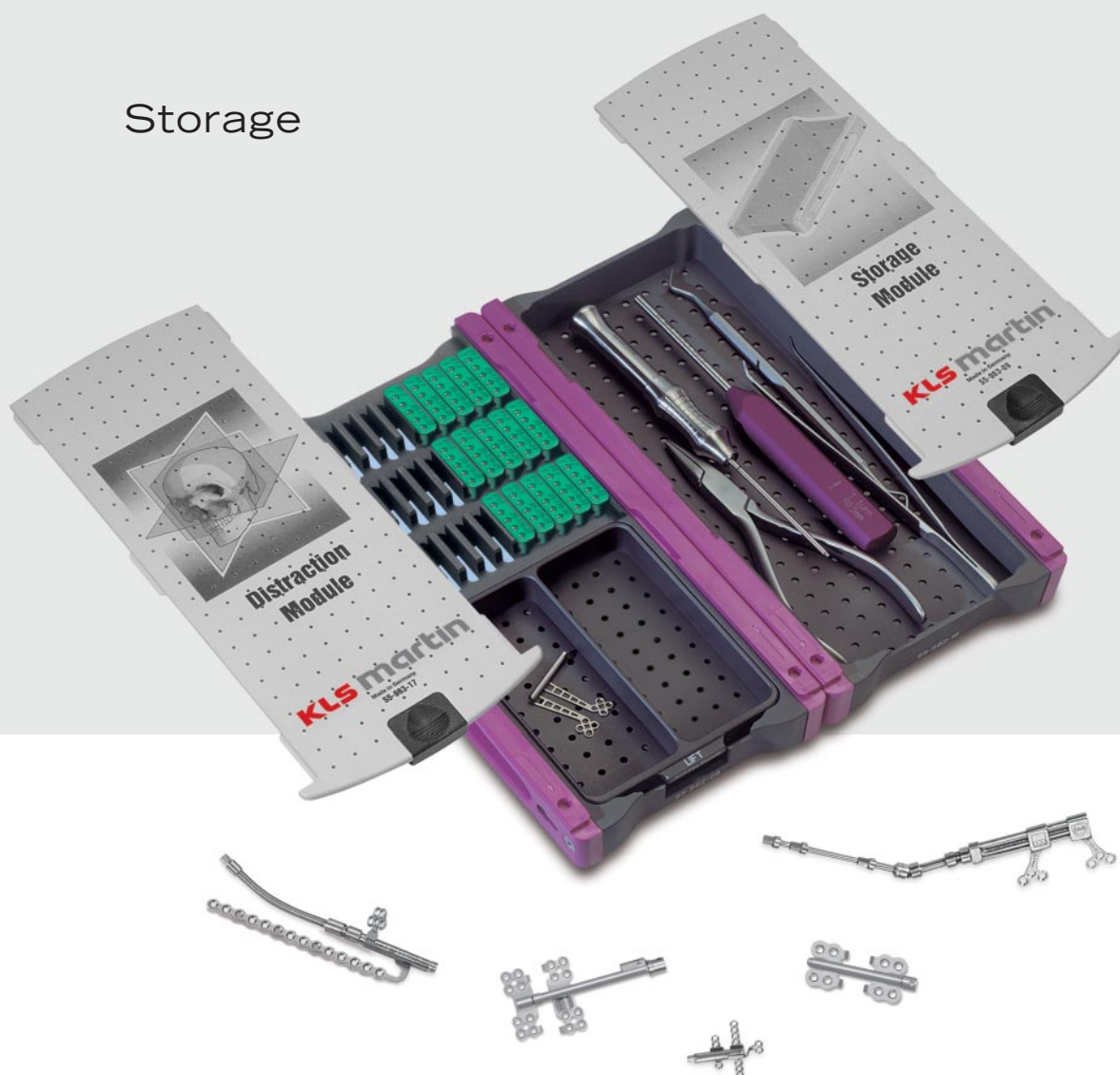

Storage

Illustrated items	Item Number
Insert module, purple	55-962-08-04
Storage module, purple	55-962-18-04
Lid for distraction module	55-963-17-04
Lid for storage module	55-963-09-04
Insert empty, 2 sections (double height)	55-964-20-04

Alternative items	Item Number
Screw storage module, purple	55-962-28-04
Twin insert module, purple	55-962-38-04
Lid for screw storage module	55-963-08-04
Lid for 3D X system	55-963-20-04
Insert empty, universal (low height)	55-964-17-04
Insert for TRACK distractors (low height)	55-964-23-04
Insert empty, 2 sections (low height)	55-964-24-04
Insert empty, 3 sections (low height)	55-964-25-04
Insert for complete 3D X devices (double height)	55-964-33-04
Insert for 3D X single components (double height)	55-964-34-04

Please note that this brochure does not replace the instruction for use. The instructions will accompany the product and must be considered before use.

If you still have any questions ...
... we will be glad to answer them anytime.

*You can reach us personally, either by e-mail
or through our customer hotline.*

Customer hotline: +49-7461-706-0
E-mail: info@klsmartin.com
Internet: www.klsmartin.com

Additional product brochures for distractors



TRACK Overview



Zurich II Distractor



Zurich II Modular
Distractor



Rotterdam Palatal
Distractor



RPE – Rapid Palatal
Distractor



RMD – Rotterdam
Midline Distractor

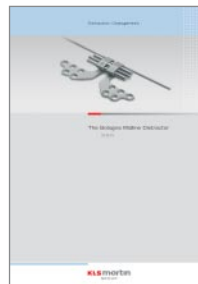

BMD – Bologna
Midline Distractor



Arnaud Machac
Distraction System

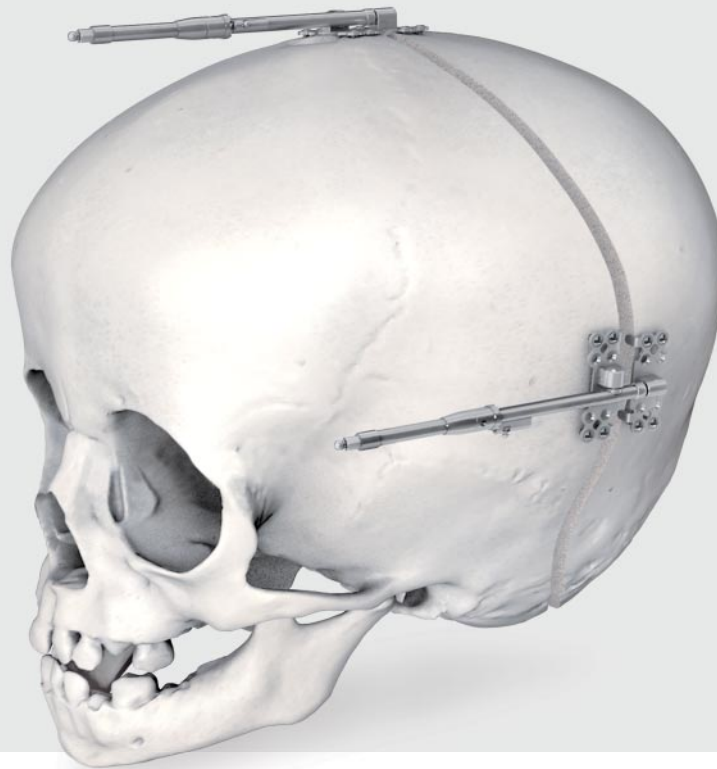

Cranial Distraction

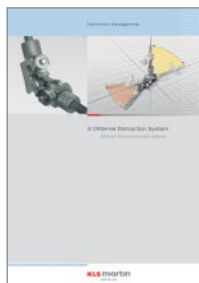

3DX – External Distraction System

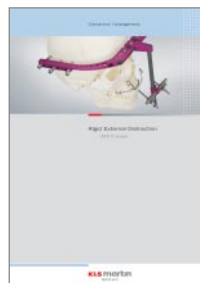

RED II – External Distraction System



ThreadLock Transport Distractor



Molina Osteo Distraction System



Patient leaflet for details

KLS Martin Group

KLS Martin France SARL
68200 Mulhouse · France
Tel. +33 3 89 51 31 50
france@klsmartin.com

KLS Martin UK Ltd.
Reading RG1 3EU · United Kingdom
Tel. +44 1189 000 570
uk@klsmartin.com

KLS Martin do Brasil Ltda.
CEP 04.531-011 São Paulo · Brazil
Tel.: +55 11 3554 2299
brazil@klsmartin.com

Gebrüder Martin GmbH & Co. KG
Representative Office
121471 Moscow · Russia
Tel. +7 499 792-76-19
russia@klsmartin.com

Martin Italia S.r.l.
20864 Agrate Brianza (MB) · Italy
Tel. +39 039 605 67 31
italia@klsmartin.com

Nippon Martin K.K.
Tokyo 113-0024 · Japan
Tel. +81 3 3814 1431
nippon@klsmartin.com

KLS Martin Australia Pty Limited
Artarmon NSW 2064 · Australia
Tel.: +61 2 9439 5316
australia@klsmartin.com

Gebrüder Martin GmbH & Co. KG
Representative Office
201203 Shanghai · China
Tel. +86 21 5820 6251
china@klsmartin.com

Martin Nederland/Marned B.V.
1271 AG Huizen · The Netherlands
Tel. +31 35 523 45 38
nederland@klsmartin.com

KLS Martin L.P.
Jacksonville, FL 32246 · USA
Tel. +1 904 641 77 46
usa@klsmartin.com

KLS Martin SE Asia Sdn. Bhd.
14100 Simpang Ampat, Penang · Malaysia
Tel.: +604 505 7838
malaysia@klsmartin.com

Gebrüder Martin GmbH & Co. KG
Representative Office
Dubai · United Arab Emirates
Tel. +971 4 454 16 55
middleeast@klsmartin.com

Gebrüder Martin GmbH & Co. KG
A company of the KLS Martin Group
KLS Martin Platz 1 · 78532 Tuttlingen · Germany
Postfach 60 · 78501 Tuttlingen · Germany
Tel. +49 7461 706-0 · Fax +49 7461 706-193
info@klsmartin.com · www.klsmartin.com

